

Simplicity

Operators Manual

**E15 Seeder Console
Actuator Drive Seed Rate Controller
with Liquid Control
A874 R1.3 V2.0.18**



Simplicity

As with any software operated equipment, software and/or hardware is in many cases changed and upgraded over the life of the equipment.

KEE Technologies software engineers are constantly working on software enhancements which will provide you with many additional benefits and features in the future.

The EAGLE System will keep on evolving! ...to ultimately improve your 'bottom line'!

KEE Technologies personnel have records of all changes implemented to your system with the subsequent serial number.

When talking to KEE Technologies Support staff, always have this manual with you, as we may ask you what version manual you are currently looking at to ensure we all talk the same language. For this purpose all pages are on the top right hand side display the manual version number and date manual was upgraded. Ie V2.0 03/06. Which means the manual is version 2.0 and the manual was upgraded in March 2006.

Below is space provided to keep records of any software and hardware upgrades you may have received.

Important information

This Simplicity Actuator manual V2.0 only applies to Simplicity Actuator SRC with software version 2.0.0 or later.

If your Simplicity Actuator SRC has software version 1.0 to 1.4 then use operators manual 'Simplicity Air Seeder Monitor' manual V1.1

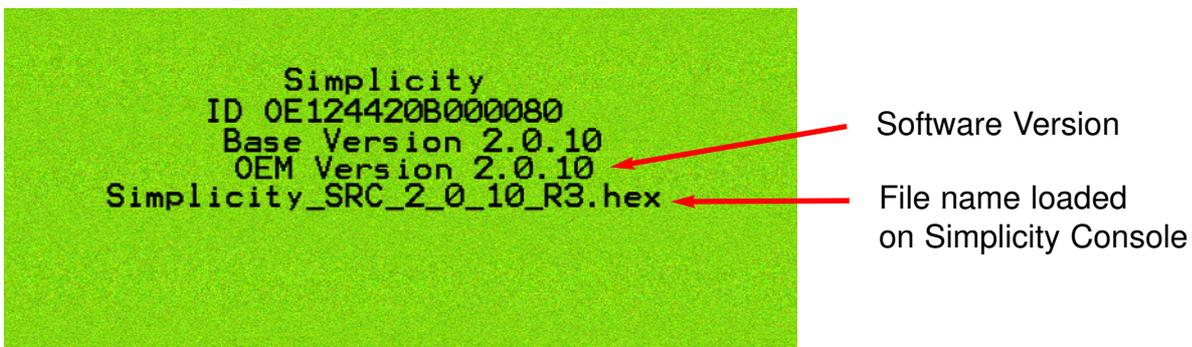

The above screen is displayed for 60 seconds each time the Simplicity Console is switched ON, using the 'POWER', button.

The software version is displayed on the 4th line 'OEM Version 2.0.10' with the '2.0.10' being the software version.

The software version 2.0.0 or later, requires 'Simplicity Air Seeder manual V2.0'

The fifth line 'Simplicity_SRC_2_0_10_R3.hex' displays the file name loaded onto the console. The 'R3' represents the Hardware revision being used on the Simplicity Console, software version 2.0.0 or later requires 'R3' hardware to run.

Type of upgrade (software or hardware)	Version	Date	Manual upgraded
Simplicity ACTUATOR SRC REV 3 Board	2.0.18	11/06	03/07

1.0 Overview	Page 9
1.01 Optional Extras	Page 11
2.0 Configuration	Page 12
2.1 Air Seeder Overview	Page 12
2.2 System Components	Page 13
2.3 Menu Manipulation	Page 14
2.4 Simplicity Console Overview	Page 15
2.4.1 The Working Screen	Page 15
2.5 Working Screen Navigation Functions	Page 17
2.6 Setup Menu	Page 20
3.0 Seeder Setup Menu	Page 21
3.1 Bin Setup	Page 22
3.1.1 Set the Number of Bins on the Machine	Page 23
3.1.2 Set the Bin Volume	Page 23
3.1.3 Select Bin Clutch for Each Bin	Page 23
3.1.4 Change the Drive Type	Page 23
3.2 Wheel Calibration Factor	Page 24
3.2.1 Set the Wheel Factor	Page 25
3.2.2 Wheel Factor Calibration	Page 25
3.2.3 Manual Entry	Page 25
3.2.4 Select Speed Source	Page 25
3.2.5 Connecting a GPS Receiver (optional)	Page 26
3.3 Width Speed and Prime Duration Setup	Page 27
3.3.1 Set the Seeding width of the Machine	Page 28
3.3.2 Set the Manual Speed	Page 28
3.4 Operating History	Page 29
3.4.1 Totals History	Page 30
3.4.2 Shafts History	Page 31
3.4.3 Fan History	Page 32
3.4.4 Pump History	Page 33
3.5 Config Setup	Page 34
3.5.1 External Master (Optional)	Page 35
3.5.2 Enable Block Head Sensor (Optional)	Page 35
3.6 Fan Pressure Gain Factor	Page 36
3.6.1 Setting the Fan Pressure Gain Factor	Page 36
4.0 Product Setup and Selection	Page 37
4.0.1 Product Selection Screen	Page 37
4.1 Product Setup	Page 38
4.1.1 Enter a Product Name	Page 39
4.1.2 Enter a Product Bin Number	Page 40
4.1.3 Enter number of Encoder Teeth	Page 40
4.1.4 Enter the Density of the Product	Page 40
4.1.5 Enter the Preset Sowing Rate 1 for the Product	Page 41
4.1.6 Enter the Preset Sowing Rate 2 for the Product	Page 41
4.1.7 Enter the Sowing Rate Increment for the Product	Page 41
4.2 Enter the Cal Factor for the Product	Page 42
4.2.1 Product Calibration	Page 43
4.2.2 Manual Entry of Cal Factor	Page 43
5.0 Zone Setup Menu	Page 44
5.1 Change the Working Zone	Page 45

6.0 Alarm Setup Menu	Page 46
6.1 Fan Alarms	Page 47
6.1.1 Fan Speed Alarm Overview	Page 47
6.1.2 Fan Pressure Overview	Page 48
6.1.3 Setting the Fan Pressure Low Alarm	Page 49
6.1.4 Adjust the Fan Pressure Low Alarm Point	Page 49
6.1.5 Setting the Fan Pressure High Alarm	Page 49
6.1.6 Adjust the Fan Pressure High Alarm Point	Page 49
6.1.7 Setting the Fan Speed Low Alarm	Page 50
6.1.8 Adjust the Fan Speed Low Alarm Point	Page 50
6.1.9 Setting the Fan Speed High Alarm	Page 50
6.1.10 Adjust the Fan Speed High Alarm Point	Page 50
6.2 Shaft Alarms	Page 51
6.2.1 Shaft Alarm Overview	Page 51
6.2.2 Setting the Shaft Stopped Alarm	Page 52
6.3 Bin Alarms	Page 53
6.3.1 Bin Low Overview	Page 54
6.3.2 Bin Empty Overview	Page 54
6.3.3 Setting the Bin Low (Sensor) Alarm	Page 55
6.3.4 Setting the Bin Empty (Contents) Alarm	Page 55
6.4 Liquid Tank Alarms (Liquid Only)	Page 56
6.4.1 Setting the Pump Speed Low Alarm	Page 57
6.4.2 Adjust the Pump Speed Low Alarm Point	Page 57
6.4.3 Setting the Pump Speed High Alarm	Page 57
6.4.4 Adjust the Pump Speed High Alarm Point	Page 57
6.4.5 Setting the Liquid Pressure Low Alarm	Page 58
6.4.6 Adjust the Liquid Pressure Low Alarm Point	Page 58
6.4.7 Setting the Liquid Pressure High Alarm	Page 58
6.4.8 Adjust the Liquid Pressure High Alarm Point	Page 58
7.0 Air Seeder Operations	Page 59
7.1 Fill a Bin	Page 60
7.2 Add Volume to a Bin	Page 60
7.3 Reset the Zone Area	Page 60
7.4 Reset the Total Area	Page 61
7.5 Change the Working Zone	Page 61
7.6 Switch a Bin ON or OFF	Page 61
7.7 Display Sowing Rates (With Master OFF)	Page 62
7.8 Increase or Decrease the Sowing Rate of a Bin	Page 62
7.9 Setting RATE 1 or RATE 2 For Each Bin	Page 62
7.10 Begin Seeding	Page 63
7.11 Return to a Preset RATE 1 or RATE 2	Page 63
7.12 Use the Manual Speed	Page 63
7.13 Adjust the Brightness of the Console Screen	Page 63

8.0 Liquid Setup	Page 64
8.1 Simplicity Console Liquid Setup	Page 65
8.2 Liquid Control Setup	Page 66
8.3 Liquid Tank Setup '1' Screen	Page 67
8.3.1 Set the Control Mode	Page 68
8.3.2 Set the Flow Meter Sensitivity	Page 68
8.3.3 Set the Max on Time	Page 68
8.3.4 Set the Min on Time	Page 69
8.3.5 Set the Gain Setting	Page 69
8.3.6 Set the PWM Setting	Page 69
8.3.7 Set Close Valve When Off	Page 70
8.3.8 Set Valve Reverse	Page 70
8.3.9 Liquid Tank Setup '2' Screen	Page 71
8.3.10 Set the Pump Speed Sensor	Page 72
8.3.11 Set the Low Speed Shutoff	Page 72
8.3.12 Set the Minimum Flow	Page 72
8.3.13 Pressure Sensor Setup	Page 73
8.3.14 Set Pressure Gain	Page 74
8.3.15 Set Pressure Sensor Type	Page 74
8.3.16 Calibrate Pressure Sensor	Page 75
8.4 Setting up a Product for a Liquid Tank	Page 77
8.5 Setting up the Pump	Page 77
8.6 Set the Flow Calibration Factor	Page 78
8.6.1 Automatic Flow Calibration	Page 79
8.6.2 Manual Flow Calibration	Page 79
8.7 Confirming Control Circuit with New Settings	Page 80
8.8 Confirming the Min and Max Rate at the Manual Speed	Page 80
9.0 Configuration Options	Page 81
9.1 Key Configuration	Page 82
9.1.1 Switch the Key Beeper ON/OFF	Page 83
9.2.2 Change the Key Beeper Time	Page 83
9.3.3 Switch the Key Repeat Enabled	Page 83
9.4.4 Adjust the Key Repeat Duration	Page 83
9.2 Alarm Configuration	Page 84
9.2.1 Alarm Beeper Overview	Page 85
9.2.2 Set the Alarm Cycle Time	Page 86
9.2.3 Set the Alarm Duty Cycle	Page 86
9.2.4 Set the Number of Alarm Cycles	Page 86
9.2.5 Switch the Alarm Beeper ON/OFF	Page 86
9.3 General Configuration	Page 87
9.3.1 Changing Between Air seeder Monitor & Seed Rate Controller	Page 88
9.3.2 Interface to an MDECU: (Actuator Drive only)	Page 88
9.3.3 Change the type of MDECU (Actuator Drive only)	Page 88
9.3.4 Check MDECU Version Number	Page 88
9.3.5 Toggle Display Polling	Page 89
9.3.6 Enter Diagnostics Mode	Page 89
9.3.7 Restore to Factory Settings	Page 89

10.0 Diagnostics Mode	Page 90
10.1 Led Test	Page 91
10.2 Switch Test	Page 92
10.3 Keys Test	Page 93
10.4 Sensors Test	Page 94
10.4.1 Checking Harness Voltages, for 3 Pin Sensors	Page 95
10.4.2 Pressure Sensor Test	Page 96
10.5 Relay Test	Page 97
10.6 Bin Levels Test	Page 98
10.6.1 Bin Level Sensor Adjustment	Page 99
10.6.2 Checking Harness Voltages, for Bin Sensor	Page 100
10.6.3 Checking Harness Voltages, Clutch	Page 100
10.7 Memory Test	Page 101
10.8 Display Test	Page 101
11.0 Alarm Messages	Page 102
11.1 Alarm Messages Overview	Page 102
11.2 Fan Alarms	Page 103
11.3 Metering Shaft Alarms	Page 103
11.4 Rate Alarms	Page 103
11.5 Bin Low (Sensor) Alarms	Page 104
11.6 Bin Empty (Contents) Alarms	Page 104
11.7 Blocked Head Alarms (optional)	Page 104
11.8 Other Alarms	Page 105
11.9 Liquid Alarms (Liquid Only)	Page 105
12.0 Specifications	Page 106
13.0. System Components	Page 107
13.1 System Components - Parts List	Page 108
14.0 Wiring Diagrams	Page 110-

1. OVERVIEW

The Simplicity Console is a control system designed to complement an air seeder by controlling the rate of any product that is being sown or spread by the seeder, and allow on the go adjustment of the required rate of product (*within the mechanical ability and physical limitations of the machine*) using the actuators to increase or decrease the output shaft speed on the Zeromax Gearbox, and in turn the metering shaft, which is driven by the Airseeder wheel (ground drive).

To achieve accurate rate control the controller requires the following information:

Wheel Calibration factor to deliver accurate ground speed.

Width actual working width of machine.

Product CAL factor. Represents the actual amount of material that is metered by 1 revolution of the metering shaft.

Encoder value. This is the number of electrical pulses the controller receives for each metering shaft revolution.

This will be factory set, at a value of '8'.

Note: If any of the Factors are not correct, proper monitoring and control cannot be achieved. Please take time to properly calculate this information. This will help you gain a clear understanding of how the system functions and ensure that your seeding operation is accurate and trouble free.

As well as the control of the seeding application, the system also monitors the status of the seeder functions such as ground speed, hectares covered, fan speed, shaft speed, fan pressure and bin levels.

Liquid Upgrade Kit

The Simplicity Seed Rate Controller is designed to also control a Liquid Channel. The principles of control are identical to a conventional spraying system with one main difference; only one section is used as opposed to multiple sections on some sprayers.

A Liquid Upgrade kit can be purchased to compliment your existing Simplicity Seedrate Control. The Liquid tank can be fitted on your existing Air Seeder bar.

See your Simplicity dealer for more information.

Variable Rate Control

With the addition of other Hardware components the Simplicity Console can be used for Region Based Prescription Variable Rate Control.

See your Simplicity dealer for further information.

The actuator operates a variable speed gearbox and requires a MDECU (Motor Drive Electronic Drive Unit) to control the actuators. The MDECU is the black control box on the air seeder that controls the actuators. The MDECU simply applies appropriate power to the actuator to change the setting of the variable speed gearbox driving the metering shaft. The actuator has a potentiometer inside of the unit that gives a voltage output proportional to the position of the actuator. This is used to detect the position of the actuator and thus the position of the gear ratio lever of the Zeromax. When first turned on in a seeding application, there is no output from the encoder disk. The actuator must operate partially until the MDECU receives pulses. Once there are pulses present, the actuator is then driven until the encoder disk information is what is expected for the target application rate. Once the correct rate is achieved, the actuator does not need to move unless there is a rate change or the bin is turned off. Note that the actuator does not move with speed changes as the metering box shaft is geared directly to the wheel, which means the metering rate will change as the speed changes, thus keeping the application rate constant. Once a rate has been set, and the bin is turned off, when turned on again with the same rate, the actuator goes back to the same position to achieve that rate.

The Actuator system also has a clutch drive circuit to activate the metering drive system and mechanically connect this to the driving wheel. The clutch requires power to be applied to keep it engaged. This clutch is activated by turning any of the bins on, and will remain on until the last bin is turned off.

The seeder drives the metering rollers from the main wheels, and the metering system needs to be turned over by hand to get the product out of the bin for calibration purposes. The procedure is detailed in the Simplicity's operator's handbook for the air seeder.

When the bin switch is turned on for calibration, the actuator is fully extended to give the maximum output of the gearbox. The Encoder disk attached to the output shaft of the gearbox monitors the rotation of the metering shaft for calibration purposes, and is also used to generate stopped shaft alarms and to control the system to the programmed rates. The weight of product drawn off for calibration needs to be as large as practical, 20 to 30 Kgs, this limits some of the errors such as position of the encoder disk magnets at the start and end of the calibration, drive backlash, product distribution across the rollers etc.

To enable the correct target rate of product delivery, it is necessary to know the position of the actuator, the weight of product delivered per revolution of the metering shaft, the speed of the seeder, and the width of the seeder. The PRODUCT CALIBRATION SCREEN sets up the calibration factor and other related information.

The calibration factor obviously will vary with product, but for most general products and systems, a factor between 0.4 and 0.8 is realistic. For canola, application rates are very low (5 kg/hectare). To achieve a realistic cal factor for canola (0.05 kg/rev), various methods are in use. They include masking off part of the metering system.

1.0.1 Optional Extras

Below is a list of optional extras that can be added to and enhance your Simplicity Controller Console. Most options can be added when purchasing your new air seeder or can be added to your air seeder at a later date.

GPS Speed kit

When this kit (part number A3023 or A1677) is fitted this allows the Console to use GPS Speed as a speed input.

This option is mainly used when a front or rear mounted bin is fitted to the tractor and no ground wheel can be used as a speed source. In this case the GPS Speed option would be fitted from the factory.

Liquid Upgrade Kit

The Simplicity Eagle can be set up to control up to 2 Liquid bins. See your Simplicity Dealer for information on upgrading your air seeder to control a liquid tank.

External Master Switch kit

An External Master switch kit (part number A601), can be fitted in the tractor cabin. This External Master switch can either be fitted on the cabin floor or within easy reach of the operator. This overrides the Master switch on the Simplicity Console.

Blocked Head Sensor kit

A Blocked Head Sensor (part number A3105) can be fitted to the air seeder the sensors will detect 'No Flow' or 'Blockages' of product in the air seeder system. The Console will display and sound a Blocked Head' warning in the Alarm window of the console; the offending sensor will display a red LED light. The kit contains 5 sensors, additional sensors can be added, up to 18 sensors can be connected to the Simplicity Console.

Eagle Seeder XLINK kit

The Eagle Seeder XLINK kit (part number A2953) allows the Simplicity Console to be connected to X10, X15 or X20 Console via a serial cable. The X20 Console will display all the tank information on the X20 Console. The X20 Console can be used for Variable Rate Control (VRC), Visual Guidance, Steer Assist; therefore all the information is displayed on the one screen.

The Simplicity Console still controls the air seeder and seeding rates but the information is displayed on the X20 Console.

Working Lights

Additional Lights can be added to the Tank Harness (See Section 13.4 for layout of harness) the lights can be connected to the LIGHT and AUX connectors on the Tank Harness. Note a maximum of 50 watts continuous for each switch is allowed when connecting to the LIGHTS and AUX connections.

When the LIGHTS or AUX are switch ON on the console and a multi-meter is put across the 2 pins, the voltage will be 12 VDC.

2. CONFIGURATION

2.1 AIR SEEDER OVERVIEW

The basic system consists of a Simplicity Console, MDECU, Actuators and the ancillary cables, sensors and mounting hardware required completing the system. The console is mounted in the cabin of the tractor, and connects to the Motor Drive Electronic Control Unit (MDECU) via a communication cable. This cable is part of the power harness going to the MDECU and actuators. The MDECU is mounted on the seeder, usually underneath or between the bins, and contains the control circuitry for the actuators. The console can be configured to control the actuator system.

The system has been designed to operate 4 separate bins, all of which can be calibrated independently, irrespective of the product in the bins. The Console can also be set up to control up to 2 liquid tanks.

The console contains all of the data for the operation of the system, such as metering roller calibration, gear ratios, alarm points, bin volumes, application rates and other fixed data such as the seeder width and wheel circumference. The console also records area covered, operating time, and monitors actuator position.

The MDECU communicates to the console via a communication link. The data received by these processors, concerns the position of the actuators that are directly operated by the processors. The data returned to the console includes the status of the system, alarms, and timing from the various sensors on the seeder. The speed of the seeder is determined from the wheel sensor on one of the main wheels on the seeder, and is sent to the console for display and calculation of the actuator position for the rate required. An alternative speed pickup connection is available on the harness near the console plug. A normal speed sensor mounted on the tractor can be connected at this point, or input from a Radar speed system may also be used.

The seeder width in the console should be the sowing width of the bar. If the Circumference or width is inaccurate, the area calculations will also be inaccurate along with the application of the product.

Temporary changes in application rate of any bin product can be achieved with a few button presses while seeding. The rate increment change is part of the initial product calibration. A manual operating speed needs to be entered into the console for correct operation, and while manual mode may not be anticipated, this value is required for calibration.

2.2 SYSTEM COMPONENTS

For a Typical 2 Bin Air Seeder

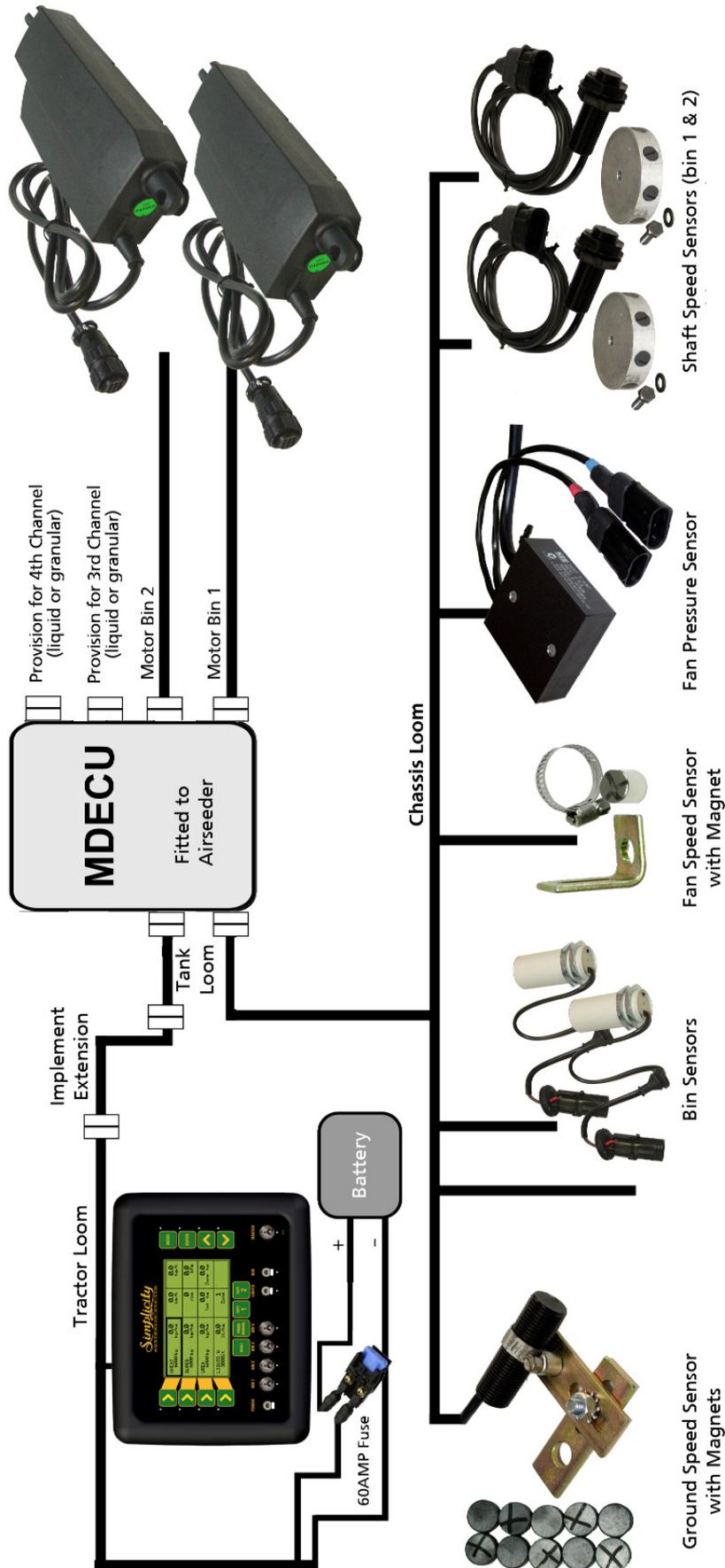

2.3 MENU MANIPULATION

2.3.1 TO MOVE THE FOCUS AROUND THE SCREEN

- The buttons (LINE 1,2 ,3 and 4) along the left hand side of the screen are aligned with a row on the screen.
- Pressing a LINE (1,2,3 OR 4) button will take you to the first focus square on that row.
- If there is no text on a row you will not be able to set the focus to that row.
- If a value is unable to be edited (ie a title or display value) you will not be able to set the focus to that window.
- To move between windows on a single row, press the corresponding left hand LINE (1,2,3 or 4) button repeatedly. The focus will scroll between available fields on the row.

2.3.2 TO ENTER THE MENU FROM THE WORKING SCREEN

- Ensure the MASTER switch is in the OFF (hold) position
- Press the MENU button
- You will be taken to the main menu screen

2.3.3 TO RETURN TO THE WORKING SCREEN

- Ensure that you are not editing a value (if you are editing a value an asterisk (*) will be shown in the box the focus is set to)
- Press the DEC button
- You will be returned to the previous menu screen
- To return to the WORKING screen the DEC button may have to be pressed several times

2.3.4 TO ENTER A MENU SCREEN

- Highlight the field displaying the menu you wish to enter
- Press the ENTER button
- You will advance to the next screen.

2.3.5 TO EDIT A VALUE

- Highlight the field displaying the value to be edited.
- Press the ENTER key. An asterisk (*) will appear in the field being edited
- Use the Inc or Dec buttons to adjust the value
- Press the ENTER button to accept and save the changed value. The asterisk (*) will disappear.

2.4 THE SIMPLICITY CONSOLE OVERVIEW

2.4.1 THE WORKING SCREEN

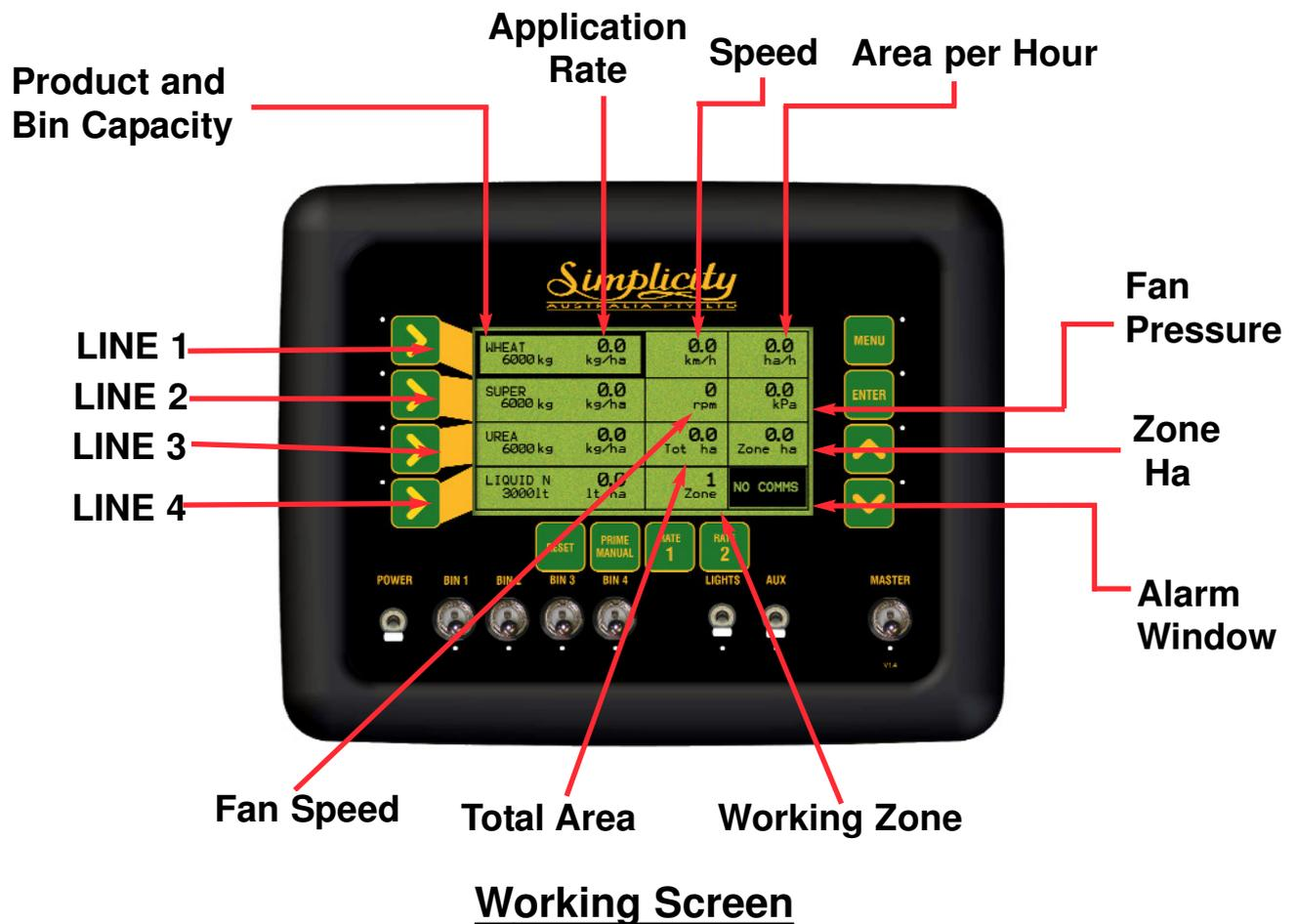

PRODUCT AND BIN CAPACITY- Shows the four bins down the left hand side of the console, starting with Bin 1 at the top through to Bin 4 down the bottom. If only two bins are selected from the SEEDER SETUP MENU then LINE 3 AND LINE 4 rows will be blank.

The window displays:

- The Product Name
- Capacity of BIN after refill, then
- Contents of BIN left as product is metered out

LINE 1 displays the Product that is being metered from BIN 1

LINE 2 displays the Product that is being metered from BIN 2

LINE 3 displays the Product that is being metered from BIN 3

LINE 4 displays the Product that is being metered from BIN 4

APPLICATION RATE- The Application rate is displayed in the same window as the Bin Contents and Capacity but to the right. The Bin Output rate displays the actual sowing rate selected for each bin and the actual sowing rate being applied.

SPEED- Displays the speed of the air seeder in km/hr from a wheel sensor mounted on the air seeder or other external sources such as a tractor radar. When a manual speed is displayed then 'MANUAL' appears under the speed; if MANUAL is not displayed then the speed is from the air seeder or tractor radar. When a GPS receiver is connected to the console and functioning, then 'GPS' will be displayed, in the Speed readout.

AREA PER HOUR- Displays the work rate of the air seeder in ha/h.

FAN PRESSURE- Displays the static air pressure as picked up from the Fan Pressure sensor mounted on the manifold near the fan. The Fan Pressure is displayed in kPa.

ZONE HA- Shows the hectares (ha) the air seeder has accumulated for the selected Working Zone as displayed in the Working Zone window.

WORKING ZONE- Displays a number between 0 and 9, the number represents what zone is being applied at the moment. The Working Zone associates Bins, Products and areas.

TOTAL AREA- The Total Area windows display the total hectares(ha) the air seeder has treated since being last reset. ie. The seeder might only be reset at the beginning of a season then the value would represent the total hectares covered since the beginning of the season.

FAN SPEED- The Fan Speed window displays the actual fan speed in rpm.

ALARMS- The alarms window displays all the current warning messages. If there is more than one warning then the warnings will cycle through each warning once every second.

See Section 11 for list of Alarms displayed in the Alarm Window and an explanation of the alarms.

2.5 WORKING SCREEN NAVIGATION FUNCTIONS

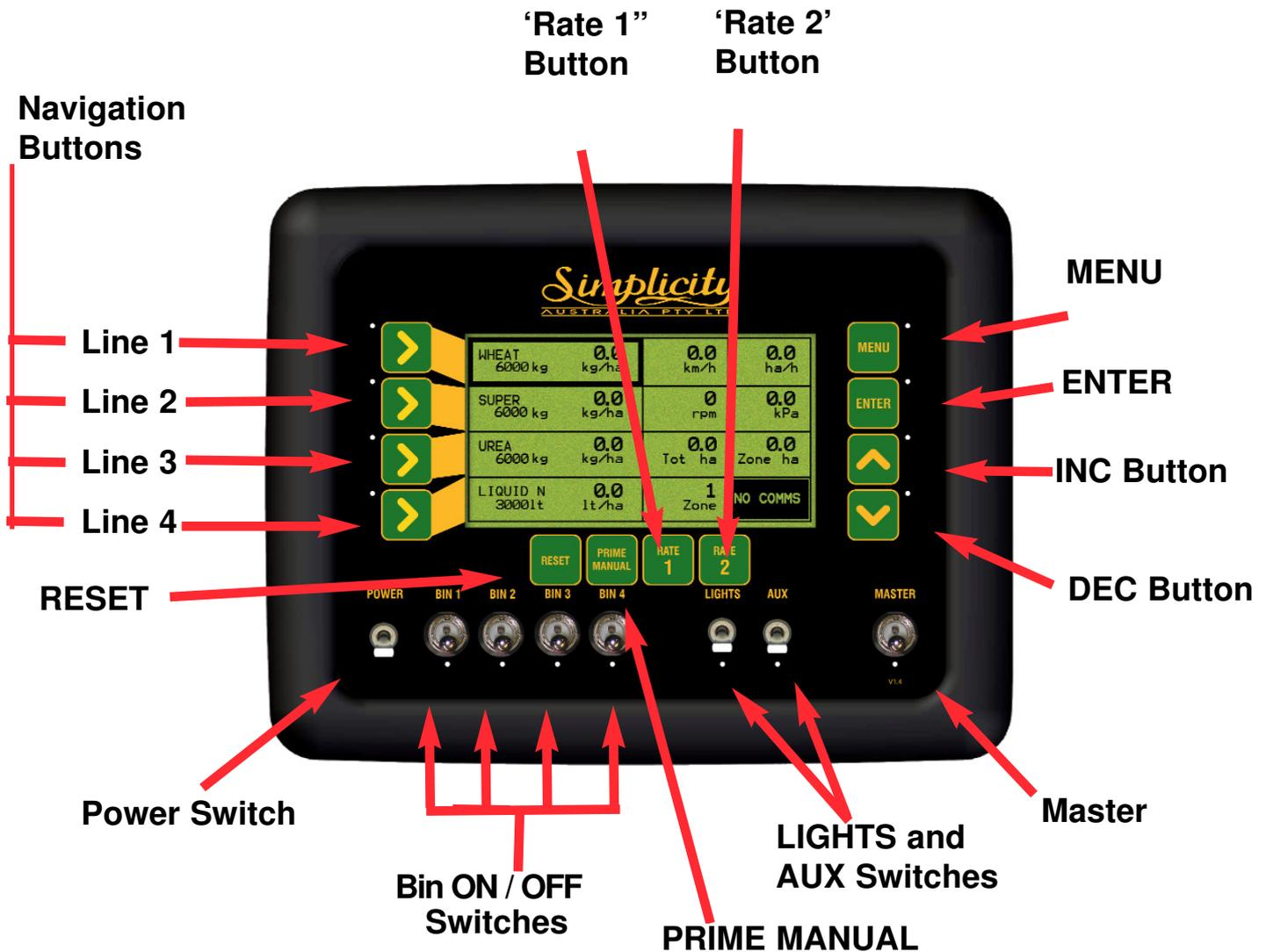

RESET - The RESET button allows the bins to be refilled in the console when the bins are empty. (See Section 7.1 for details).

The RESET button also returns the current application rate(kg/ha) to the original application rate, when the focus window is on the selected bin.

The RESET button allows the ZONE AREAS and TOTAL AREA to be reset. (See Section 7.3 and 7.4 for details).

PRIME/MANUAL- When the PRIME/MANUAL button is pressed, 'MANUAL' is displayed in the 'Speed Window', along with the value (km/h) set for the Manual Speed.

The Prime function does not operate when the Simplicity Console is set up as a Actuator Controller.

POWER- The Simplicity console is turned ON and OFF by this switch on the front panel.

Note: When the Power switch is switched ON, a screen displaying details regarding the console's software and hardware versions are displayed for 60 seconds; then the 'Working Screen' is displayed. To advance to the 'Working Screen' immediately select any button on the Simplicity Console.

NAVIGATION BUTTONS

1) Setup menu-LINE 1, LINE 2, LINE 3 AND LINE 4 buttons allow the operator to navigate in the SETUP MENU.

LINE 1 selects line 1 of the display; LINE 2 selects line 2 of the display and so on for LINE 3 and LINE 4. If the operator selects LINE 3 then the window on LINE 3 will be highlighted. If the operator presses LINE 3 again then the column 2 will be highlighted; if permitted. When LINE 3 is pressed again, column 3 will be highlighted. If LINE 3 is pressed a third time the first column will be highlighted.

2) Navigating the Screen

LINE 1 button highlights the Product that is being metered from BIN 1

LINE 2 button highlights the Product that is being metered from BIN 2

LINE 3 button highlights the Product that is being metered from BIN 3

LINE 4 button highlights the Product that is being metered from BIN 4

LINE 3 button Pressed twice highlights the TOTAL HA window.

LINE 3 button Pressed three times highlights the ZONE HA window.

LINE 4 button Pressed twice highlights the WORKING ZONE window

BIN SWITCHES ON/OFF-

These switches turn individual Bins ON or OFF; down is ON

The red LED aligned with each BIN switch, indicates the status of each Product (BIN). When the LED light is:

- **OFF** - The Bin Switch for that bin is switched OFF, temporarily.
- **Flashing**- Bin Switch is switched ON but not metering. MASTER is OFF
- **ON**- The Bin Switch is switched ON, MASTER is ON and Product is being metered at the calibrated sowing rate which is displayed "live" as the Application Rate.

MASTER- The MASTER switch engages the 'Main Clutch', ON or OFF; and will start metering all shafts selected for operation.

LIGHTS and AUX SWITCHES- These 2 switches, switch any WORKLIGHTS fitted on the air seeder ON or OFF. The switches when switched ON will apply 12 VDC to the connectors. Worklights with up to maximum 50 Watts can be connected to each switch.

LED- LIGHT EMITTING DIODES (LED). The LED's on the under side of the Bin Switches indicate the status of the BINS.

The LED's under the LIGHTS, AUX and MASTER switches indicate the status of the switches.

The LED's near the LINE (1,2,3 and 4) will turn ON when the set rate for the product being dispensed is not equal to the PRESET RATE 1.

The LED's near the LINE (1,2,3 and 4) will turn OFF when the PRESET RATE 1 is selected.

INC/DEC Buttons-

Using the Menu System

The INC/DEC buttons when in the MENU screens allow the operator to increase and decrease factors (when a asterisk (*) appears next to the value), in the SETUP MENU.

The DEC button also returns to the Working Screen from any Menu screen, (the button may have to be pressed several times to return to the WORKING SCREEN). Press DEC the button once to return to the previous menu.

Working Screen

The INC/DEC buttons when on the Working Screen allow the operator to:

- 1- Increase or Decrease the application rates of the selected Bin.
- 2- Set a Bin weight for the selected Bin.
- 3- Select a Zone

ENTER- When the ENTER button is pressed, the value within the highlighted window, has an asterisk (*) appear next to the value. The value can be increased or decreased using the INC/DEC buttons. Press the ENTER button again to lock-in and save the value.

MENU- When the MASTER switch is in the OFF position, the MENU button, when pressed, is the gateway into the SETUP MENU's screen for the Console.

RATE 1- The RATE 1 button sets the sowing rate as selected for PRESET RATE 1 for the highlighted Bin.

RATE 2- The RATE 2 button sets the sowing rate as selected for PRESET RATE 2 for the highlighted Bin.

2.6 SETUP MENU

The *SETUP MENU* allows the operator to setup all the parameters required to monitor the Simplicity Air Seeder. Work through the manual to ensure all values and alarms are set correctly

- Press MENU. To enter *SETUP MENU* screen, from the Working Screen. Ensure the *MASTER* switch is in the *OFF* position.

Note: all procedures assume the operator is starting from the "Working Screen"

- To advance to the *SEEDER SETUP MENU* see Section 3.0
- To advance to the *PRODUCTS SETUP MENU* see Section 4.0
- To advance to the *ZONES SETUP MENU* see Section 5.0
- To advance to the *ALARMS SETUP MENU* see Section 6.0
- To advance to the *LIQUID SETUP MENU* see Section 8.0



Setup Screen

3.0 SEEDER SETUP MENU

- Press MENU
- Press ENTER to advance to the SEEDER SETUP screen



Seeder Setup Screen

3.1 BIN SETUP

- Press MENU
- Press ENTER to advance to SEEDER SETUP screen
- Press LINE 1 to highlight BIN SETUP
- Press ENTER to advance to BIN SETUP

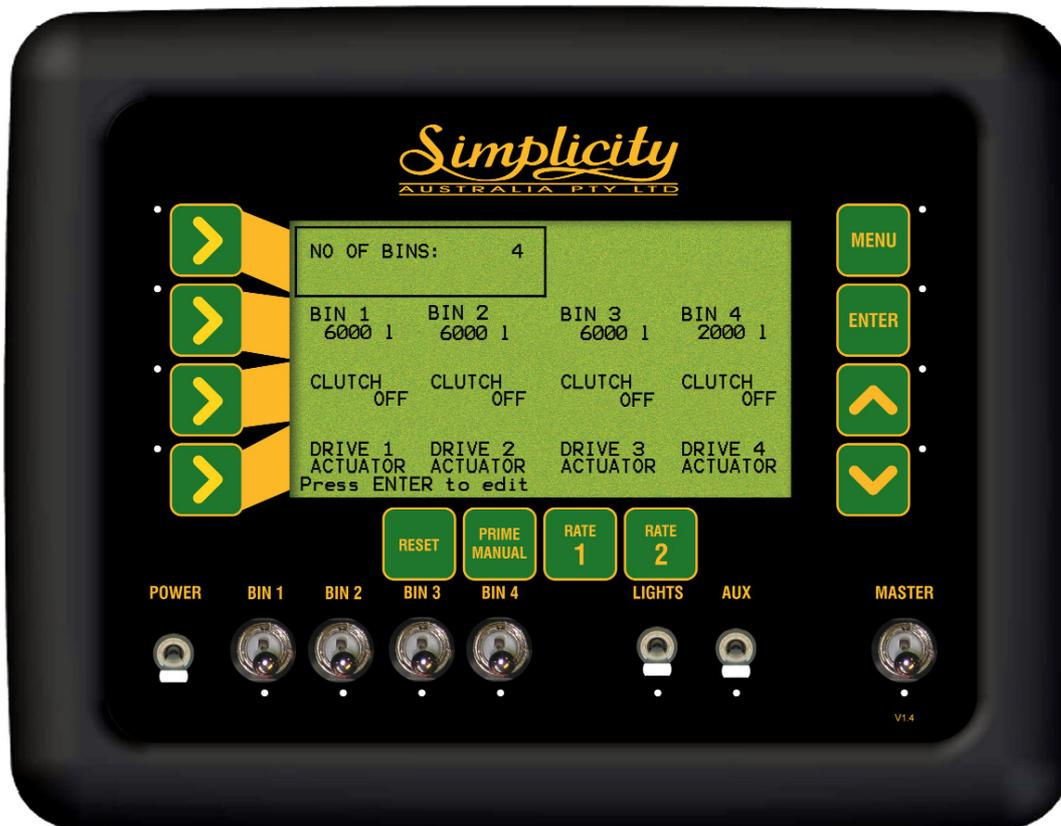

Bin Setup Screen

3.1.1 SET THE NUMBER OF BINS ON THE AIR SEEDER

This option sets the number of bins the console is monitoring. The number of bins selected will be reflected on the Bin Setup screen and the 'Working Screen'. This also disables alarms for the bins not selected.

- Press MENU
- Press ENTER to advance to the SEEDER SETUP screen
- Press ENTER to advance to the BINS SETUP screen
- Press ENTER to edit 'NO OF BINS'. An asterisk (*) appears.
- Use Inc/Dec buttons, to set the number of Bins
- Press ENTER to accept the changes

3.1.2 SET THE BIN VOLUME

This option allows the input of the bin volume for each bin, in litres (l). The 'Bin Volume' and the 'Product Density' (see Section 4.1.4) will determine the 'Bin Weight' in kilograms (kg) for each product selected.

- Press MENU
- Press ENTER to advance to the SEEDER SETUP screen
- Press ENTER to advance to the BINS SETUP screen
- Press LINE 2 to highlight BIN VOLUMES
- Press LINE 2 repeatedly, to cycle through to the bin to be edited
- Press ENTER to edit the Volume of the BIN. An asterisk (*) appears.
- Use Inc/Dec buttons to set the bin capacity.

Note: Capacity changes in 10 litre increments; by holding the Inc or Dec buttons down the value will change more quickly.

- Press ENTER to accept changes

3.1.3 SELECT BIN CLUTCH FOR EACH BIN (Monitor Only)

By default the CLUTCH for each bin is set to OFF.

*When the Simplicity Console is setup as an Actuator Controller the CLUTCH for each of the **BINS MUST BE** set to **OFF** and the settings can not be changed.*

3.1.4 CHANGE THE DRIVE TYPE

When the Simplicity Console is set up for ACTUATOR control; then the DRIVE TYPE for each bin should display ACTUATOR. If not see Section 9.3.3 to change the MDECU MODE to ACTUATOR.

The Simplicity Console can also be set up to control 1 or 2 liquid tanks. BINS 3 and/or 4 can be set up as LIQUID tanks.

See Section 8.0 if one of the BINS has been selected for LIQUID.

- Press MENU
- Press ENTER to advance to the SEEDER SETUP screen
- Press ENTER to advance to the BINS SETUP screen
- Press LINE 3 to highlight DRIVE TYPE.
- Press LINE 3 repeatedly, to cycle through to the bin to be edited
- Press ENTER to edit the DRIVE TYPE. An asterisk (*) appears.
- Use Inc/Dec buttons to change the DRIVE TYPE. Select either ACTUATOR for Actuator Drive Bins OR LIQUID for a Liquid Bin.

Note: Only BINS 3 or 4 can be set up for LIQUID.

- Press ENTER to accept changes

3.2 WHEEL CALIBRATION FACTOR

- Press MENU
- Press ENTER to advance to SEEDER SETUP screen
- Press LINE 2 to highlight WHEEL FACTOR
- Press ENTER to advance to Wheel Factor Screen

SPEED SOURCE:

EXTERNAL is the default and can not be changed, which means the speed source is taken from the wheel sensor on the Air Seeder.

The Wheel Sensor is normally connected to the plug marked 'Ground Speed' on the 'Tank Harness, on the air seeder; see Section 14.0 for wiring diagram.

This wheel factor value is the distance travelled by the air seeder per pulse from the wheel (speed) sensor. The value will vary considerably between models, with typical values between .25 and 1 metre per pulse. Values less than 0.05 metres and more than 5 metres will not give good metering rate control and must be avoided.

GPS Speed Source

An optional GPS may be fitted (part number A3023 or A1677), this enables the console to use GPS speed. If a GPS receiver is connected to the console and working, then no setup or settings are required to be entered into the console. If the console detects valid GPS data then the console will automatically display the GPS speed and override the speed reading from the wheel sensor.

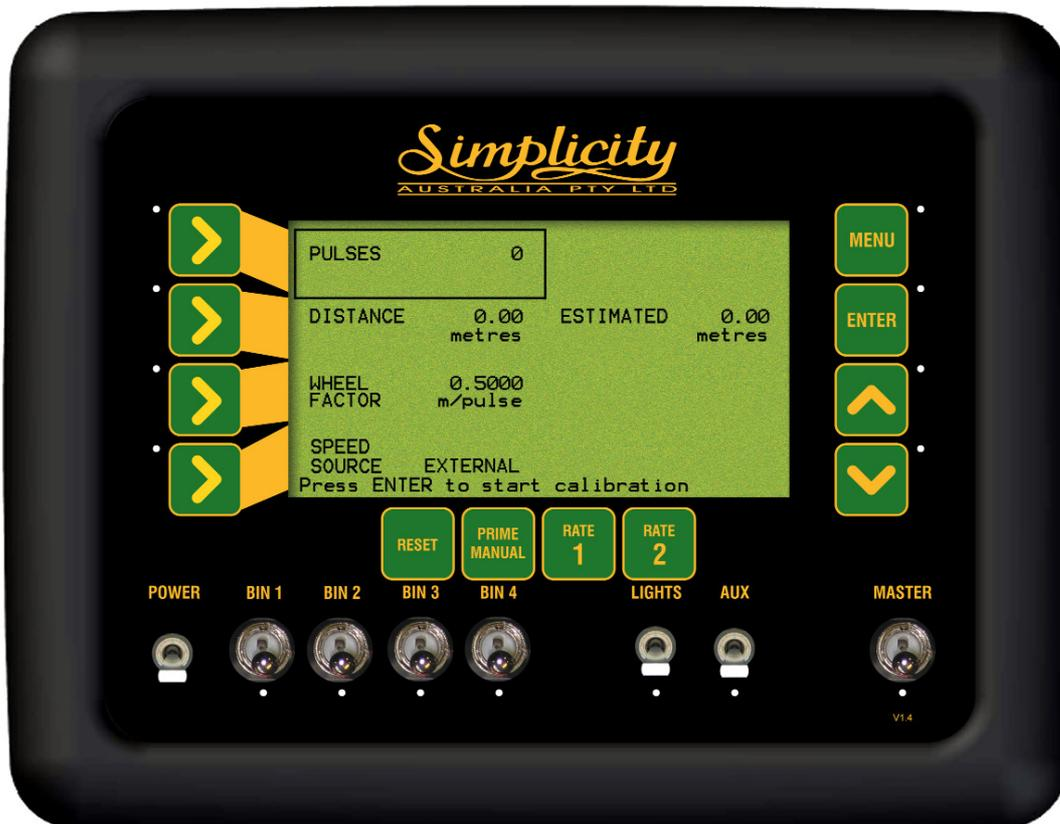

Wheel Factor Screen

3.2.1 SET THE WHEEL FACTOR

The operator can choose to do an Automatic Wheel Calibration (see Section 3.2.2) or Manual Entry (see Section 3.2.3)

- Press MENU
- Press ENTER to advance to SEEDER SETUP screen
- Press LINE 2 to highlight WHEEL FACTOR
- Press ENTER to advance to Wheel Factor Screen

3.2.2 WHEEL FACTOR CALIBRATION

- Press ENTER to begin wheel factor calibration
- Drive forward a measured distance, say 100m. *The PULSES count will accumulate as you travel forwards. The DISTANCE value and ESTIMATED value will accumulate in metres as you travel forwards. These values will accumulate reflecting the current WHEEL FACTOR value; if the value is close then the ESTIMATED and DISTANCE value will also be close to the actual distance travelled.*
The DISTANCE value is the value to be edited and the ESTIMATED value is a display value only.
- Once the known distance is reached, press ENTER. *Focus will automatically jump to DISTANCE line of the screen*
- Use Inc/Dec buttons to change the DISTANCE value to reflect the actual distance travelled
- Press ENTER to accept the value. *Wheel factor will be automatically calculated and displayed, on the WHEEL FACTOR line.*

3.2.3 MANUAL ENTRY OF WHEEL FACTOR

The current 'Wheel Factor' is displayed. This section allows the manual entry of the 'Wheel Factor'.

- Press LINE 3 to highlight the WHEEL FACTOR window
- Press ENTER to edit the value

Note: To calculate the WHEEL FACTOR

- Calculate the actual tyre circumference of the air seeder tyre. (Refer to Page 20 of the Simplicity Operators Manual- PM 004A).
- Divide the ACTUAL tyre circumference by '9'. (9 is the number of pulses the wheel sensor receives for one revolution of the air seeder tyre.)

$$\frac{\text{Actual Air Seeder Wheel Circumference}}{9} = \text{WHEEL FACTOR}$$

- Use INC/DEC buttons to manually change the WHEEL FACTOR.
Note: WHEEL FACTOR values can be edited, by holding the Inc or Dec buttons down, the value will change more quickly.
- Press ENTER to accept the value

3.2.4 SELECT SPEED SOURCE

Note: The SPEED SOURCE is set on and displays EXTERNAL, and can not be changed.

3.2.5 Connecting a GPS Receiver (optional)

A GPS Receiver can be connected to the Simplicity Console as an alternate to using a wheel sensor on the air seeder, as a speed source.

When the GPS Receiver is connected to the Simplicity Console and working correctly then the Speed readout will display the actual GPS speed in km/h and 'GPS' will be displayed in the Speed readout window.

Items required:

1. Either a A1677 (1Hz), A3023 (5Hz) or A2272 (5Hz) GPS Receiver can be used with the Simplicity Console.
2. A1507 Null modem cable
3. A3017 Power adaptor

The GPS Receiver has to be configured to output:

1. Baud Rate: 9600bps
2. Outputting GPVGA and GPVTG NMEA data strings.
3. Either 1Hz or 5Hz update rates can be used.

Connecting the GPS Receiver

1. Mount the GPS receiver on top of the tractor cab with a clear view of the sky and not obstructed by any objects. Mount the GPS receiver at least 1 metre away from other antenna's (eg. two radio, mobile phone antenna).
2. Connect the A3017 Power adaptor to the 2 pin weather pack on the GPS Receiver's harness.
3. Connect the 3 pin plug of the A3017 Power adaptor to the plug marked 'Radar' on the Tractor Harness (See Section 14.0). This connector uses pins B and C to provide 12 VDC power to the GPS Receiver.
4. Connect the A1507 9 pin DB9 Null modem cable to the DB9 9 pin connector on the GPS Receiver harness.
5. Connect the other end of the A1507 null modem harness to the connector marked 'COMMS' on the back of the Simplicity Console.

Setting Up

No settings are required to be entered into the Simplicity Console when a GPS Receiver is used for GPS Speed. The Simplicity Console will automatically override the speed source. If the GPS 'drops out' then the Console will use the wheel sensor speed source. There fore it is recommended the Wheel calibration be set up correctly in case of GPS dropouts.

'GPS' will be displayed in the Speed readout window along with the actual GPS speed in km/h. 'GPS' will be displayed whenever the GPS speed is detected.

Note: If using an XLink to connect the Simplicity Console to an X20 or X15 Console. Then the GPS Receiver will be connected directly to the X20 or x15 Console's COM Port and the Xlink DB9 serial cable will be connected to the connector marked COMMS on the Simplicity console and a COM Port on the X20/X15 Console. Also part numbers A3017 and A1507 will not be required when using an XLink connection.

Then select the 'GPS Speed' option in the Xlink setup.

3.3 WIDTH and SPEED SETUP

- Press MENU
- Press ENTER to advance to the SEEDER SETUP screen
- Press LINE 3 to highlight WIDTH, MANUAL SPEED AND PRIME DURATION screen
- Press ENTER to advance to WIDTH, MANUAL SPEED AND PRIME DURATION screen.



Width and Manual Speed Screen

3.3.1 SET THE SEEDING WIDTH OF THE MACHINE

Note: This is the effective seeding or operating width of the Air Seeder

- Press MENU
- Press ENTER to select SEEDER SETUP
- Press LINE 3 to highlight, WIDTH SPEED AND PRIME DURATION
- Press ENTER to advance to the WIDTH, MANUAL SPEED AND PRIME DURATION screen
- Press ENTER to edit the WIDTH. *An asterisk (*) will appear.*
- Use Inc/Dec buttons to set the width of the Air Seeder bar.
Width changes in 1cm increments
- Press ENTER to accept the value

3.3.2 SET THE MANUAL SPEED

During calibrations, the Manual Speed is used; by the Simplicity controller to simulate a ground speed when the seeder is stationary.

The Manual Speed can be used to operate the system if the speed sensor fails. This value is normally set to the speed used for normal seeding operations, ie, 7 to 10 km/h. This is one of the factors that must be present to enable correct motor operation during calibration.

- Press MENU
- Press ENTER to advance to SEEDER SETUP screen
- Press LINE 3 to highlight, WIDTH SPEED AND PRIME DURATION
- Press ENTER to advance to the WIDTH, MANUAL SPEED AND PRIME DURATION screen
- Press LINE 2 to highlight MANUAL SPEED
- Press ENTER to edit Manual Speed. *An asterisk (*) will appear.*
- Use Inc/Dec buttons to set the manual speed
- Press ENTER to accept the value

3.4 OPERATING HISTORY

- Press MENU
- Press ENTER to advance to SEEDER SETUP screen
- Press LINE 4 to highlight OPERATING HISTORY
- Press ENTER to advance to the OPERATING HISTORY screen
- Press LINE 1, 2 3 or 4 to highlight the type of history values you wish to view.
Note: The PUMP HISTORY will only appear if at least one of the DRIVES is selected as a Liquid Drive, in Section 3.1.4.
- Press ENTER to advance to the history page highlighted
Note: None of these values are editable by the customer



Operating History Screen

3.4.1 TOTALS HISTORY

These values are a record of the air seeder operation over its life.

These values are not editable by the user



Totals History Screen

3.4.2 SHAFTS HISTORY

*These values are a record of the air seeder operation over its life.
These values are not editable by the user.*



Shaft History Screen

3.4.3 FAN HISTORY

These values are a record of the air seeder operation over its life.

These values are not editable by the user



Fan History Screen

3.4.4 PUMP HISTORY (LIQUID ONLY)

*These values are a record of the air seeder operation over its life.
These values are not editable by the user.*

*This screen is only displayed when at least one Liquid Drive is selected in
Section 3.1.4.*



Fan History Screen

3.5 CONFIG SETUP

- Press MENU
- Press ENTER to advance to SEEDER SETUP screen
- Press LINE 1 TWICE to highlight CONFIG SETUP
- Press ENTER to advance to CONFIG SETUP screen



CONFIG SETUP Screen

3.5.1 EXTERNAL MASTER (OPTIONAL)

An External Master Switch (part number A601) may be purchased as an option. If a Master Switch is fitted then the option has to be enabled in this section. A Remote Master Switch can be floor mounted to allow for easy access to the remote switch. When an External Master Switch is fitted, the EXTERNAL MASTER setting must be set to ON.

- Near the back of the Simplicity console where the tractor harness connects into the console will be '2' three pin weather-pak plugs one marked 'RADAR' the other marked 'MASTER', connect the External Master Switch plug, to the plug marked 'MASTER'.
See Section 14 for Wiring Diagrams
- Then mount the switch in a convenient position.
- The CABIN switch overrides the MASTER switch, on the Simplicity console.
- A Cabin Switch can be floor mounted in the tractor cabin, to allow easy accessible remote switching, to turn the MASTER, ON or OFF.

TO CHANGE THE EXTERNAL MASTER SETTING

- Press MENU
- Press ENTER to advance to SEEDER SETUP screen
- Press LINE 1 to highlight the MASTER SWITCH
- Press ENTER to advance to MASTER SWITCH screen
- Press ENTER to edit EXTERNAL MASTER. *An asterisk (*) will appear.*
- Press Inc/Dec buttons to select between ON and OFF.
When EXTERNAL MASTER is selected ON "MASTER TYPE CABIN" appears to the right.

Note: There is an option to select TILLAGE as an option for MASTER TYPE but this option is not available with the current wiring harness.

- Press ENTER to accept changes

3.5.2 ENABLE BLOCKED HEAD SENSOR (OPTIONAL)

A Blocked Sensor kit can be installed with the new air seeder or added to later. The Blocked Sensor kit requires a Simplicity Console with Revision 3 board or later and for the option to be Enabled.

The standard Blocked Sensor kit consists of 5 Blocked Head sensors. Up to 18 blocked head sensors can be fitted to the Simplicity Console. Therefore up to 18 heads can be monitored

For further information please contact your local Simplicity dealer.

For operation and wiring diagrams of the Blocked Head Sensor, refer to the manual that came with the Blocked Head kit.

- Press MENU
- Press ENTER to advance to SEEDER SETUP screen
- Press LINE 1 TWICE to highlight the CONFIG. SETUP
- Press ENTER to advance to CONFIG. SETUP screen
- Press LINE 2 to highlight the BLOCKED HEAD SENSOR
- Press ENTER to edit BLOCKED HEAD SENSOR. *An asterisk (*) will appear.*
- Press Inc/Dec buttons to select between ON and OFF. *Select ON if a BLOCKED HEAD SENSOR is fitted OR OFF if not fitted. Default is OFF.*
- Press ENTER to accept changes.

3.6 Fan Pressure Gain Factor

3.6.1 Setting the Fan Pressure Gain Factor

- Press MENU
- Press ENTER to advance to SEEDER SETUP screen
- Press LINE 2 twice to highlight FAN PRESS SENSOR
- Press ENTER to advance to FAN PRESSURE GAIN screen
- Press ENTER to edit PRESSURE GAIN.
An asterisk () will appear.*
- Press Inc/Dec buttons to select between 1X or 2X. Default is 'X1'
Note: 'X1' Fan Pressure Gain is the default setting for Simplicity Actuator Consoles with software version 2.0.0 or later and connected to a MDECU X2 Pressure Gain should only be selected if directed by a KEE Service Representative depending on the Simplicity console hardware fitted to your air seeder .
- Press ENTER to accept changes



Fan Pressure Gain Screen

4.0 PRODUCT SETUP AND SELECTION

4.0.1 PRODUCT SELECTION SCREEN

- Press MENU
- Press LINE 2 to highlight PRODUCT SETUP
- Press ENTER to advance to PRODUCTS SELECTION screen. *The PRODUCTS SELECTION screen allows the operator to see what products are stored and what Bins the products are setup for.*
- Select which product is to be edited by using the LINE 1, 2,3 or 4 buttons. Repeated pressing moves the focus across the screen.
- Once the PRODUCT is highlighted,
- Press ENTER, to advance to the PRODUCT SETUP screen, where the details of each product can be viewed and edited. See Section 4.1

Up to 16 products can be entered and calibrated in the PRODUCT SETUP MENU, ready for seeding. Below is the PRODUCTS SELECTION screen showing the default screen with a list of products. These products can be changed and edited to reflect the products used with your farming operation.



Product Selection Screen

4.1 PRODUCT SETUP

For each product that is going to be sown it is necessary to enter the following:

- 1- Product Name
- 2- Bin Number
- 3- Number of Encoder Teeth
- 4- Density of Product
- 5- Preset Sowing RATE 1
- 6- Preset Sowing RATE 2
- 7- Sowing Rate Increment/Decrement
- 8- Calibration Factor

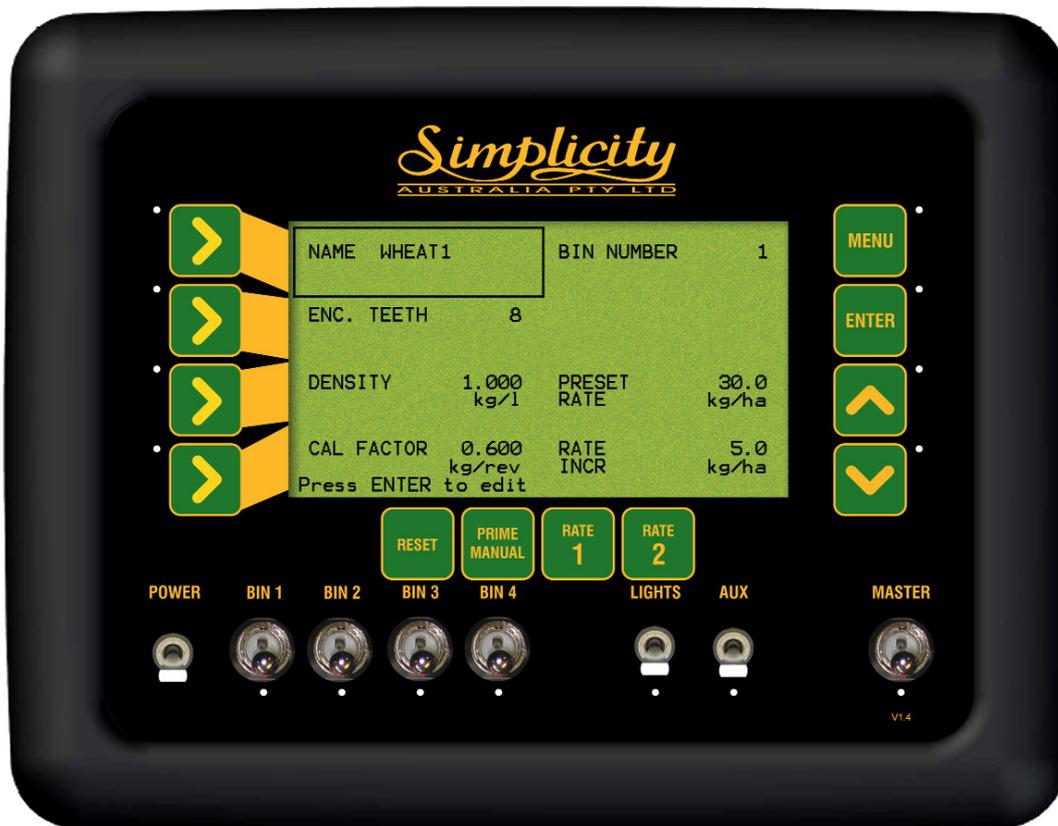

Product Setup Screen

4.1.1 ENTER A PRODUCT NAME

- Press MENU
- Press LINE 2 to highlight PRODUCTS SETUP
- Press ENTER to advance PRODUCTS SELECTION screen
- Use the LINE 1, 2, 3 or 4 buttons to select the product you wish to edit. Repeated pressing of LINE buttons moves the focus across the screen
- Press ENTER to select the PRODUCT to be edited and advance to the Product Setup screen
- Press ENTER to edit the PRODUCT NAME. A 'Selecting' asterisk (*) will appear under the first character of the name.

- Press MENU button. Another asterisk (*) will appear to the left of the PRODUCT NAME, this is called the 'Editing' asterisk This means the character with the asterisk (*) under it can now be edited. See Screen below.
- Press Inc/Dec buttons to change the character. The Inc/Dec buttons can be pressed once and will move one letter at a time, or the Inc/Dec buttons can be held down to scroll through the values quicker. The Inc button scrolls forward through the alphabet and numerals, the Dec scrolls backwards through the alphabet and numerals. The values are available in this order: A to Z (letters in Upper case), a to z (letters in Lower case), space (), comma (,), minus (-), full stop (.), forward slash (/), numerals 0 -9.
- Press MENU button. The 'Editing' asterisk (*) disappears, the value is now locked in.
- Press the INC button to move the 'Selecting' asterisk (*) to the next character to the right. Repeat the above procedure until the product has been edited, to create the desired 8 character name
- Press ENTER to accept the changes to the Product Name.

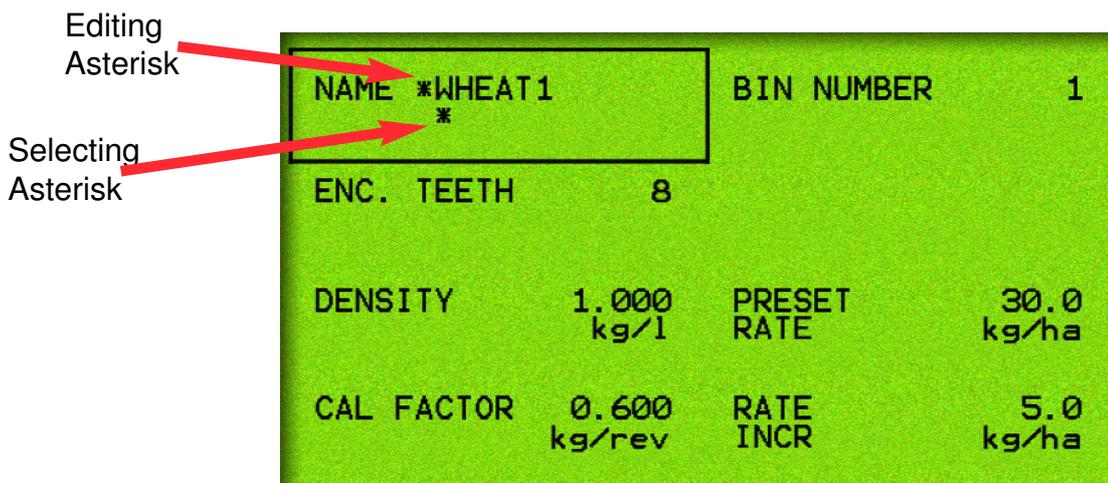

Product Name in Edit Mode

The above screen shows the 'Selecting' asterisk (*) below the 'W' character and the 'Editing' asterisk (*) to the left of the Product Name. Using the Inc/Dec buttons the 'W' character can be edited.

4.1.2 ENTER A PRODUCT BIN NUMBER

- Press MENU
- Press LINE 2 to highlight PRODUCTS SETUP
- Press ENTER to advance PRODUCTS SELECTION screen
- Use the LINE 1, 2, 3 or 4 buttons to select the product you wish to edit.
Repeated pressing of LINE buttons moves the focus across the screen
- Press ENTER to select the product
- Press LINE 1 to highlight the BIN NUMBER
- Press ENTER to edit the Bin Number for the product.
An asterisk () appears*
- Press Inc/Dec buttons to set the Bin Number for the product
- Press ENTER to accept the changes

4.1.3 ENTER NUMBER OF ENCODER TEETH

Note: The ENC. TEETH value is the number of pulses the shaft sensor for the BIN, receives for one revolution of the metering shaft. The number of Encoder Teeth is set at '8' and can not be changed.

4.1.4 ENTER THE DENSITY OF THE PRODUCT

Note: The DENSITY of the product will determine the "actual" product weight of each bin.

- Press MENU
- Press LINE 2 to highlight PRODUCTS SETUP
- Press ENTER to advance PRODUCTS SELECTION screen
- Use the LINE 1, 2, 3 or 4 buttons to select the product you wish to edit.
Repeated pressing of LINE buttons moves the focus across the screen
- Press ENTER to select the product
- Press LINE 3 to highlight DENSITY
- Press ENTER to edit the DENSITY. *An asterisk (*) will appear.*
- Press Inc/Dec buttons to set the DENSITY of the product.
Density changes in 1 gram increments
- Press ENTER to accept the changes

4.1.5 ENTER THE PRESET SOWING RATE 1 FOR THE PRODUCT

- Press MENU
- Press LINE 2 to highlight PRODUCTS SETUP
- Press ENTER to advance PRODUCTS SELECTION screen
- Use the LINE 1, 2, 3 or 4 buttons to select the product you wish to edit.
Repeated pressing of LINE buttons moves the focus across the screen
- Press ENTER to select the product
- Press LINE 3 twice to highlight the PRESET RATE
- Press the RATE 1 button to edit the PRESET RATE 1. *When the RATE 1 button is pressed, (1) will appear next to PRESET RATE, indicating RATE 1 was selected and the current preset rate will be displayed in kg/ha.*
- Press ENTER to edit the Preset Sowing Rate for RATE 1.
An asterisk () will appear.*
- Press Inc/Dec buttons to set the Preset Sowing Rate for RATE 1, for the product.
Preset Rate changes in 0.1 kg increments
- Press ENTER to accept the changes to RATE 1.

4.1.6 ENTER THE PRESET SOWING RATE 2 FOR THE PRODUCT

- With PRESET RATE highlighted
- Press the RATE 2 button to edit the PRESET RATE 2. *When the RATE 2 button is pressed, (2) will appear next to PRESET RATE, indicating RATE 2 was selected and the current preset rate for RATE 2 will be displayed in kg/ha.*
- Press ENTER to edit the Preset Sowing Rate for RATE 2.
An asterisk () will appear.*
- Press Inc/Dec buttons to set the Preset Sowing Rate for RATE 2, for the product.
Preset Rate changes in 0.1 kg increments
- Press ENTER to accept the changes for RATE 2.

4.1.7 ENTER THE SOWING RATE INCREMENT/DECREMENT FOR THE PRODUCT

- Press MENU
- Press LINE 2 to highlight PRODUCTS SETUP
- Press ENTER to advance PRODUCTS SELECTION screen
- Use the LINE 1, 2, 3 or 4 buttons to select the product you wish to edit.
Repeated pressing of LINE buttons moves the focus across the screen
- Press ENTER to select the product
- Press LINE 4 twice to highlight RATE INC
- Press ENTER to edit the Sowing Rate Increment.
An asterisk () will appear*
- Press Inc/Dec buttons to change the Sowing Rate Increment. for the product
Rate Increment changes in 0.1 kg/ha increments
- Press ENTER to accept the changes

4.2 ENTER THE CAL FACTOR FOR THE PRODUCT

- Press MENU
- Press LINE 2 to highlight PRODUCTS SETUP
- Press ENTER to advance PRODUCTS SELECTION screen
- Use the LINE 1, 2, 3 or 4 buttons to select the product you wish to edit.
Repeated pressing of LINE buttons moves the focus across the screen
- Press ENTER to select the PRODUCT to be edited and advance to the Product Setup screen
- Press LINE 4 to highlight the CAL FACTOR
- Press ENTER to advance to the CAL FACTOR screen.

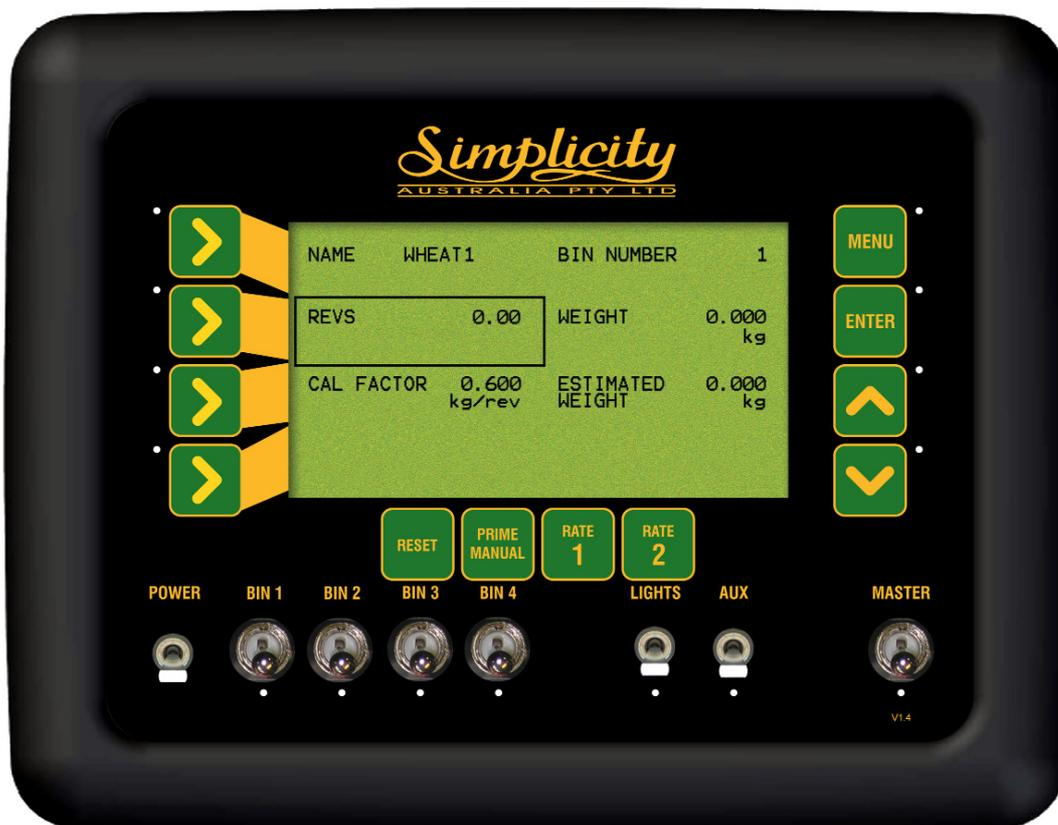

CAL FACTOR SCREEN

4.2.1 PRODUCT CALIBRATION

- Press ENTER to begin CAL FACTOR CALIBRATION.

An asterisk (*) will appear next to REVS

- *Manually turn over the metering shaft of the BIN being calibrated, (if the Calibration Screen displays 'BIN 2' then 'BIN 2' metering shaft should be turned over using the crank handle)*

The REVS count will begin accumulating as the metering shaft turns. The WEIGHT value and ESTIMATED WEIGHT value will accumulate in kgs as the product is being metered. These values will accumulate reflecting the current CAL FACTOR value for the product; if the CAL FACTOR value is close then the ESTIMATED WEIGHT and WEIGHT value will also be close to the actual weight being metered out. The WEIGHT value is the value to be edited and the ESTIMATED WEIGHT value is a display value only.

- Once approximately 10-15kg of product has been dispensed into the collection tray. Press ENTER.
The focus will automatically jump to the WEIGHT window, on the screen.
- Weigh the product dispensed into the collection tray.
- Change the value in the WEIGHT window, using the INC/DEC buttons so the value is the same as the actual weight of the product dispensed.
- Press ENTER to accept value. The Cal factor will be automatically calculated and displayed.

Each BIN should be calibrated for each product that is going to be used in the bin. 16 different products can be calibrated and stored within the console. Eg. If Urea is going to be used in Bins 1 and 2 on the air seeder; then each BIN must be calibrated separately for UREA. The console will store a:cal factor, preset sowing rate 1, preset sowing rate 2, sowing rate increment and density for UREA BIN 1 and another set of values for UREA BIN 2. When seeding with UREA in bin 1 then the operator would select UREA BIN 1 and all the factors stored with UREA BIN 1 would be retrieved.

All the different products being used in each different bin can be calibrated and stored in the console before the operator starts seeding.

4.2.2 MANUAL ENTRY OF CAL FACTOR

- Press LINE 3 to choose line 3 of the display
- Press ENTER to edit the value
- Use Inc/Dec (Up and down arrows) to change the cal factor. Cal factor changes in 1gram/rev increments
- Press ENTER to accept the value

5.0 ZONE SETUP MENU

- Press MENU
- Press LINE 3 to highlight ZONES SETUP
- Press ENTER to advance to the ZONES SETUP screen



Zone Setup Screen

5.1 CHANGE THE WORKING ZONE

- Press MENU
- Press LINE 3 to highlight ZONES SETUP
- Press ENTER to advance to the ZONES SETUP screen
- Press ENTER to change the zone number. *An asterisk (*) will be shown next to the zone number*
- Use Inc/Dec buttons to change the zone number. There are 10 Zones to select from (0-9). As the operator scrolls through the different Working Zones using the Inc/Dec buttons; the operator will see the different products selected for each bin.
- Press ENTER to accept the value. Once the Working Zone has been selected the operator will now go to Section 5.2 to select the products for each bin.

5.2 PRESETTING OF ZONES

- Press MENU
- Press LINE 3 to highlight ZONES SETUP
- Press ENTER to advance to the ZONES SETUP
- Press LINE 2 to select the Bin that needs to be edited
- Scroll through the bins by repeated pressing of the LINE 2 button until focus is set to the Bin to be edited.
- Press ENTER to edit the product for the Bin Number. *An asterisk (*) will be shown next to the bin number*
- Use Inc/Dec buttons to scroll through the products that have been calibrated for that bin
The operator can only select products that have been calibrated for that bin.
- Press ENTER to accept the product for that bin
- Press LINE 2 to highlight the next Bin to be edited.
- Press ENTER to edit the product for the Bin Number. *An asterisk (*) will be shown next to the bin number*
- Use Inc/Dec buttons to scroll through the products that have been calibrated for that bin
- Press ENTER to accept the product for that Bin
- Repeat the above procedure until a product has been selected for each bin. The first zone is now set up.

To setup another Working Zone go to Section 5.1 (Change the Working Zone) and select another Working Zone number. Then proceed to Section 5.2 (Presetting of Zones) to select a product for each bin; for that Working Zone. Repeat the above procedure until all Working Zones, that are required have been setup, Then see Section 7.5 (Change Working Zone) to select a Working Zone from the Working Screen

6.0 ALARM SETUP MENU

- Press MENU
- Press LINE 4 to highlight ALARMS SETUP
- Press ENTER to advance to the ALARMS SETUP screen.
- Press ENTER to advance to the OPERATING HISTORY screen
- Press LINE 1, 2 3 or 4 to highlight the type of Alarm you wish to view.
Note: The LIQUID TANK ALARMS will only appear if at least one of the DRIVES is selected as a Liquid Drive, in Section 3.1.4.
- Press ENTER to advance to the history page highlighted
Note: None of these values are editable by the customer



Alarm Setup Screen

6.1 FAN ALARMS

6.1.1 FAN SPEED ALARM OVERVIEW

A sensor is mounted on the fan to determine the speed of the fan in rpm. When the FAN SPEED LOW ALARM is turned ON and the FAN SPEED LOW ALARM POINT rpm is set; when the fan speed rpm drops below that threshold point a LOW FAN SPEED alarm will appear in the alarm window. The FAN SPEED LOW ALARM POINT is usually set at 20% below the normal operating speed of the fan.

When the FAN SPEED HIGH ALARM is turned ON and the FAN SPEED HIGH ALARM POINT rpm is set; when the fan speed rpm goes over that threshold point, a HIGH FAN SPEED alarm will appear in the alarm window. The FAN SPEED HIGH ALARM POINT is usually set at 20% above the normal operating speed of the fan.

When the FAN SPEED LOW and FAN SPEED HIGH are turned OFF; the ALARM POINTS for each disappear.



Fan Alarm Screen

6.1.2 FAN PRESSURE OVERVIEW

A pressure transducer sensor is mounted on the air seeder chassis near the fan to determine the pressure of the system in kPa. The operating pressure of any system is affected by fan speed, tube blockages, product density, application rates, air density and even the prevailing wind. This alarm, if set too close to the operating pressure, will trigger if any of the above conditions change. When set correctly, the pressure alarm can indicate a fault or failure in the system.

When the FAN PRESS LOW alarm is turned ON and the FAN PRESS LOW ALARM POINT is set in kPa; when the pressure of the system drops below that threshold point a LOW FAN PRESS alarm will appear in the alarm window on the console. The FAN SPEED LOW ALARM POINT value is usually set 1.5 to 2 kPa below the operating pressure.

When the FAN PRESS HIGH alarm is turned ON and the FAN PRESS HIGH ALARM POINT is set in kPa; when the pressure of the system goes over that threshold point, a HIGH FAN PRESS alarm will appear in the alarm window. The FAN PRESS HIGH ALARM POINT is usually set 1.5 to 2 kPa above the operating pressure.

When the FAN PRESS LOW and FAN PRESS HIGH are turned OFF, the ALARM POINTS for each disappear.

6.1.3 SETTING THE FAN PRESSURE LOW ALARM

- Press MENU
- Press LINE 4 to highlight the ALARM SETUP
- Press ENTER to advance to ALARMS SETUP screen
- Press ENTER to advance to the FAN ALARMS screen
- Press ENTER to edit the FAN PRESS LOW alarm.
An asterisk () will be displayed*
- Use Inc/Dec buttons to switch the alarm ON or OFF
- Press ENTER to accept the changes

6.1.4 ADJUST THE FAN PRESSURE LOW ALARM POINT

- Press MENU
- Press LINE 4 to highlight the ALARM SETUP
- Press ENTER to advance to ALARMS SETUP screen
- Press ENTER to advance to the FAN ALARMS screen

Note: If the alarm is OFF, turn the alarm ON as explained in Section 6.1.3

- Press LINE 1 to highlight the ALARM POINT
- Press ENTER to edit the value. *An asterisk (*) will be displayed*
- Use Inc/Dec buttons to adjust the alarm point
- Press ENTER to accept the changes

6.1.5 SETTING THE FAN PRESSURE HIGH ALARM

- Press MENU
- Press LINE 4 to highlight the ALARM SETUP
- Press ENTER to advance to ALARMS SETUP screen
- Press ENTER to advance to the FAN ALARMS screen
- Press LINE 2 to choose the FAN PRESS HIGH line
- Press ENTER to edit the value. *A star(*) will be displayed*
- Use Inc/Dec buttons to switch the alarm ON or OFF
- Press ENTER to accept the changes

6.1.6 ADJUST THE FAN PRESSURE HIGH ALARM POINT

- Press MENU
- Press LINE 4 to highlight the ALARM SETUP
- Press ENTER to advance to ALARMS SETUP screen
- Press ENTER to advance to the FAN ALARMS screen
- Press LINE 2 to highlight the FAN PRESS HIGH line

Note: If the alarm is off, turn the alarm on as explained in Section 6.1.5

- Press LINE 2 to highlight the alarm point
- Press ENTER to edit the value. *A star (*) will be displayed*
- Use Inc/Dec buttons to adjust the ALARM POINT
- Press ENTER to accept the changes

6.1.7 SETTING THE FAN SPEED LOW ALARM

- Press MENU
- Press LINE 4 to highlight the ALARM SETUP
- Press ENTER to advance to ALARMS SETUP screen
- Press ENTER to advance to the FAN ALARMS screen
- Press LINE 3 to highlight FAN SPEED LOW
- Press ENTER to edit the FAN SPEED LOW alarm.
An asterisk () will be displayed*
- Use Inc/Dec buttons to switch the alarm ON or OFF
- Press ENTER to accept the changes

6.1.8 ADJUST THE FAN SPEED LOW ALARM POINT

- Press MENU
- Press LINE 4 to highlight the ALARM SETUP
- Press ENTER to advance to ALARMS SETUP screen
- Press ENTER to advance to the FAN ALARMS screen
- Press LINE 3 to highlight the FAN SPEED LOW line

Note: If the alarm is OFF, turn the alarm On as explained in Section 6.1.7

- Press LINE 3 to highlight the alarm point
- Press ENTER to edit the value. *An asterisk (*) will be displayed*
- Use Inc/Dec buttons to adjust the ALARM POINT
- Press ENTER to accept the changes

6.1.9 SETTING THE FAN SPEED HIGH ALARM

- Press MENU
- Press LINE 4 to highlight the ALARM SETUP
- Press ENTER to advance to ALARMS SETUP screen
- Press ENTER to advance to the FAN ALARMS screen
- Press LINE 4 to highlight the FAN SPEED HIGH line
- Press ENTER to edit the FAN SPEED HIGH alarm.
An asterisk () will be displayed*
- Use Inc/Dec buttons to switch the alarm ON or OFF
- Press ENTER to accept the changes

6.1.10 ADJUST THE FAN SPEED HIGH ALARM POINT

- Press MENU
- Press LINE 4 to highlight the ALARM SETUP
- Press ENTER to advance to ALARMS SETUP screen
- Press ENTER to advance to the FAN ALARMS screen
- Press LINE 4 to highlight the FAN SPEED HIGH line

Note: If the alarm is OFF, turn the alarm ON as explained in Section 6.1.7

- Press LINE 4 to highlight the alarm point
- Press ENTER to edit the value. *An asterisk (*) will be displayed*
- Use Inc/Dec buttons to adjust the ALARM POINT
- Press ENTER to accept the changes

6.2 SHAFT ALARMS

6.2.1 SHAFT ALARM OVERVIEW

A shaft sensor is mounted on each of the metering shafts. Therefore if there are 3 bins on the air seeder, there will be 3 shaft sensors.

A shaft alarm occurs because there is no signal as expected from the metering shaft sensor and is used to check the gear ratio entered into the console.

If a drive chain or gear was to break, then the SHAFT # STOPPED (# represents bin number) will appear in the alarm window on the console. The alarm will persist until the problem is rectified.

Another common cause for a shaft alarm is that the sensor may have shifted. They should be mounted so that the magnet passes the sensor with a clearance of approximately 2 to 3 mm.

The SHAFT ALARM can be turned OFF or ON for each bin. The default setting is ON.



Shaft Alarm Screen

6.2.2 SETTING THE SHAFT STOPPED ALARM

- Press MENU
- Press LINE 4 to highlight ALARM SETUP
- Press ENTER to advance to the ALARMS SETUP screen
- Press LINE 2 to highlight SHAFT ALARMS
- Press ENTER to advance to the SHAFT ALARMS screen
- Press LINE 1 to highlight SHAFT 1
- OR Press LINE 2 to highlight SHAFT 2
- OR Press LINE 3 to highlight SHAFT 3
- OR Press LINE 4 to highlight SHAFT 4
- Press ENTER to edit the SHAFT STOPPED alarm.
An asterisk () will be displayed*
- Use Inc/Dec buttons to switch the alarm ON or OFF
- Press ENTER to accept the changes

Note: Repeat the above procedure to switch the SHAFT STOPPED alarms ON or OFF for the remaining bins.

6.3 BIN ALARMS

- Press MENU
- Press LINE 4 to highlight ALARM SETUP
- Press ENTER advance to the ALARM SETUP screen
- Press LINE 3 to highlight BIN ALARMS
- Press ENTER to advance to the BIN ALARMS screen



Bin Alarm Screen

6.3.1 BIN LOW OVERVIEW

In each bin there is a sensor that sets an alarm once the product level falls below the sensor. When product in the bin covers the bin sensor the light on the back of the sensor will be off and there will be no alarms.

When the product level falls below the sensor a BIN # LOW alarm will appear in the alarm window. The alarm will keep cycling in the alarm window, until the bin is refilled, with product.

The LOW BIN alarm can be turned ON or OFF, by default it is turned ON. The LOW BIN alarm maybe turned off if using canola or similar seed, it is possible that the amount put in the bin does not cover the bin level sensor.

The sensor is normally calibrated when new with Urea, (lightest density product in general use) on 12 volts and will suit most applications and products. Adjustment of these sensors may be required due to different operating voltages of the system, or different product densities.

6.3.2 BIN EMPTY OVERVIEW

The BIN EMPTY ALARM is generated from the console. During seeding, the signal from the metering shaft sensor is used to decrease the bin weight based on the calibration factor.

If set correctly, this alarm will indicate the last grain of seed going through the metering rollers, and cause the BIN # EMPTY (# represents bin number) alarm to cycle in the alarm window on the console. The console can electronically reset the counter, after the bins have been physically filled, see Section 7.1.

The BIN EMPTY can be switched ON, therefore the alarm will flash and beep when the last grain is calculated to pass over the metering rollers

The BIN EMPTY can be switched OFF, to turn the alarm OFF.

6.3.3 SETTING THE BIN LOW (SENSOR) ALARM

- Press CAL
 - Press LINE 4 to highlight ALARM SETUP
 - Press ENTER to advance to the ALARM SETUP screen
 - Press LINE 3 to highlight BIN ALARMS
 - Press ENTER to advance to the BIN ALARMS screen
 - Press ENTER to edit the BIN 1 SENSOR. *An asterisk (*) will be displayed*
 - Use Inc/Dec buttons to switch the alarm ON or OFF
 - Press ENTER to accept the changes
- THEN Press LINE 2 to highlight BIN 2 SENSOR
OR Press LINE 3 to highlight BIN 3 SENSOR
OR Press LINE 4 to highlight BIN 4 SENSOR
- Press ENTER to edit the BIN # : SENSOR. *An asterisk (*) will be displayed*
 - Use Inc/Dec buttons to switch the alarm ON or OFF
 - Press ENTER to accept the changes

6.3.4 SETTING THE BIN EMPTY (CONTENTS) ALARM

- Press CAL
 - Press LINE 4 to highlight ALARM SETUP
 - Press ENTER advance to the ALARM SETUP screen
 - Press LINE 3 to highlight BIN ALARMS
 - Press ENTER to advance to the BIN ALARMS screen
 - Press LINE 1 to highlight BIN 1 CONTENTS
- OR Press LINE 2 twice to highlight BIN 2 CONTENTS
OR Press LINE 3 twice to highlight BIN 3 CONTENTS
OR Press LINE 4 twice to highlight BIN 4 CONTENTS
- Press ENTER to edit the BIN EMPTY alarm.
An asterisk () will be displayed*
 - Use Inc/Dec buttons to select ON or OFF
If ON is selected then the BIN # EMPTY alarm will come on when the air seeder has calculated the last of the product has been metered.
If OFF is selected the alarm is disabled
 - Press ENTER to accept changes

6.4 LIQUID TANK ALARMS (LIQUID ONLY)

- Press MENU
- Press LINE 4 to highlight ALARM SETUP
- Press ENTER advance to the ALARM SETUP screen
- Press LINE 4 to highlight LIQUID TANK ALARMS
- Press ENTER to advance to the LIQUID TANK ALARM screen

This screen is only displayed when at least one Liquid Drive is selected in Section 3.1.4.



Liquid Tank Alarm Screen

6.4.1 SETTING THE PUMP SPEED LOW ALARM

- Press MENU
- Press LINE 4 to highlight the ALARM SETUP
- Press ENTER to advance to ALARMS SETUP screen
- Press LINE 4 to highlight LIQUID TANK ALARMS
- Press ENTER to advance to the LIQUID TANK ALARMS screen
- Press ENTER to edit the PUMP SPEED LOW alarm.
An asterisk () will be displayed*
- Use INC/DEC buttons to switch the alarm ON or OFF
- Press ENTER to accept the changes

6.4.2 ADJUST THE PUMP SPEED LOW ALARM POINT

- Press MENU
- Press LINE 4 to highlight the ALARM SETUP
- Press ENTER to advance to ALARMS SETUP screen
- Press LINE 4 to highlight LIQUID TANK ALARMS
- Press ENTER to advance to the LIQUID TANK ALARMS screen

Note: If the alarm is OFF, turn the alarm ON as explained in Section 6.4.1

- Press LINE 1 to highlight the ALARM POINT
- Press ENTER to edit the value. *An asterisk (*) will be displayed*
- Use INC/DEC buttons to adjust the alarm point
- Press ENTER to accept the changes

6.4.3 SETTING THE PUMP SPEED HIGH ALARM

- Press MENU
- Press LINE 4 to highlight the ALARM SETUP
- Press ENTER to advance to ALARMS SETUP screen
- Press LINE 4 to highlight LIQUID TANK ALARMS
- Press ENTER to advance to the LIQUID TANK ALARMS screen
- Press LINE 2 to highlight the PUMP SPEED HIGH alarm
- Press ENTER to edit the value. *A asterisk (*) will be displayed*
- Use INC/DEC buttons to switch the alarm ON or OFF
- Press ENTER to accept the changes

6.4.4 ADJUST THE PUMP SPEED HIGH ALARM POINT

- Press MENU
- Press LINE 4 to highlight the ALARM SETUP
- Press ENTER to advance to ALARMS SETUP screen
- Press LINE 4 to highlight LIQUID TANK ALARMS
- Press ENTER to advance to LIQUID TANK ALARMS screen

Note: If the alarm is OFF, turn the alarm ON as explained in Section 6.4.3

- Press LINE 2 to highlight the ALARM POINT
- Press ENTER to edit the value. *A asterisk (*) will be displayed*
- Use Inc/Dec buttons to adjust the ALARM POINT
- Press ENTER to accept the changes

6.4.5 SETTING THE LIQUID PRESSURE LOW ALARM

- Press MENU
- Press LINE 4 to highlight the ALARM SETUP
- Press ENTER to advance to ALARMS SETUP screen
- Press LINE 4 to highlight LIQUID TANK ALARMS
- Press ENTER to advance to the LIQUID TANK ALARMS screen
- Press LINE 3 to highlight LIQ PRESS LOW alarm
- Press ENTER to edit the LIQ PRESS LOW alarm.
An asterisk () will be displayed*
- Use INC/DEC buttons to switch the alarm ON or OFF
- Press ENTER to accept the changes

6.4.6 ADJUST THE LIQUID PRESSURE LOW ALARM POINT

- Press MENU
- Press LINE 4 to highlight the ALARM SETUP
- Press ENTER to advance to ALARMS SETUP screen
- Press LINE 4 to highlight LIQUID TANK ALARMS
- Press ENTER to advance to the LIQUID TANK ALARMS screen

Note: If the alarm is OFF, turn the alarm ON as explained in Section 6.4.5

- Press LINE 3 twice to highlight the ALARM POINT
- Press ENTER to edit the value. *An asterisk (*) will be displayed*
- Use INC/DEC buttons to adjust the alarm point
- Press ENTER to accept the changes

6.4.7 SETTING THE LIQUID PRESSURE HIGH ALARM

- Press MENU
- Press LINE 4 to highlight the ALARM SETUP
- Press ENTER to advance to ALARMS SETUP screen
- Press LINE 4 to highlight LIQUID TANK ALARMS
- Press ENTER to advance to the LIQUID TANK ALARMS screen
- Press LINE 4 to highlight LIQ PRESS HIGH alarm
- Press ENTER to edit the LIQ PRESS HIGH alarm.
An asterisk () will be displayed*
- Use INC/DEC buttons to switch the alarm ON or OFF
- Press ENTER to accept the changes

6.4.8 ADJUST THE LIQUID PRESSURE HIGH ALARM POINT

- Press MENU
- Press LINE 4 to highlight the ALARM SETUP
- Press ENTER to advance to ALARMS SETUP screen
- Press LINE 4 to highlight LIQUID TANK ALARMS
- Press ENTER to advance to the LIQUID TANK ALARMS screen

Note: If the alarm is OFF, turn the alarm ON as explained in Section 6.4.7

- Press LINE 4 twice to highlight the ALARM POINT
- Press ENTER to edit the value. *An asterisk (*) will be displayed*
- Use INC/DEC buttons to adjust the alarm point
- Press ENTER to accept the changes

7.0 AIR SEEDER OPERATIONS



Working Screen

7.1 FILL A BIN

Note: When the Bins are physically filled with product, each Bin must be electronically FILLED.

- MASTER switch in the OFF position
- Press LINE 1 to highlight Bin 1
- OR • Press LINE 2 to highlight Bin 2
- OR • Press LINE 3 to highlight Bin 3
- OR • Press LINE 4 to highlight Bin 4
- Press ENTER once a Bin has been highlighted.
An asterisk () will be displayed next to the remaining bin weight, in the Product and Capacity Window*
- Press RESET. The bin weight returns to full.
- Press ENTER to accept the change.

7.2 ADD VOLUME TO A BIN

This allows setting a Bin Weight when not filling the Bin to full. I.E. Half filling the bin with product. This then allows to put the actual weight of product in the bin.

- MASTER switch in the OFF position
- Press LINE 1 to highlight Bin 1
- OR • Press LINE 2 to highlight Bin 2
- OR • Press LINE 3 to highlight Bin 3
- OR • Press LINE 4 to highlight Bin 4
- Press ENTER once a Bin has been highlighted.
An Asterisk () will be displayed next to the bin weight*
- Press Inc/Dec buttons to adjust the volume.
*The Inc or Dec buttons can be held down to speed up the changes.
Volume changes in 10kg increments*
- Press ENTER to accept the change

Note: When Bins are filled with product each Bin must be electronically FILLED.

7.3 RESET THE ZONE AREA

The resetting of Zone Area, resets the area accumulated by the air seeder for the current Working Zone displayed in the Working Zone window.

To reset the Zone Area for another Working Zone, select another Working Zone as set out in Section 7.5. Then repeat the above procedure.

- MASTER switch in the OFF position
- Press LINE 3 several times, to highlight the ZONE HA window
- Press ENTER to RESET the ZONE AREA.
An asterisk () will be displayed next to Zone*
- Press RESET. "Reset?" Will be displayed in the window
- Press ENTER to RESET the ZONE HA for Working Zone selected
- OR • Press Dec button to cancel and NOT reset the Zone HA
- Press ENTER to accept the change.

7.4 RESET THE TOTAL AREA

This resets the Total Ha accumulated by the air seeder.

- MASTER switch in the OFF position
 - Press LINE 3 twice to highlight the TOTAL AREA window
 - Press ENTER to RESET the TOTAL AREA.
A star () will be displayed next to ha, in the TOTAL HA window*
 - Press RESET button. "Reset?" Will be displayed in the window
 - Press ENTER to RESET the TOTAL HA value to zero.
- OR
- Press the Dec button to cancel
 - Press ENTER to accept the change

7.5 CHANGE THE WORKING ZONE

- Press LINE 4 twice to move to WORKING ZONE window
- Press ENTER to select the area. *An asterisk (*) will be displayed next to Zone*
- Press Inc/Dec buttons to set the Working Zone number.
 - 1) *The Working Zone number will be displayed in the Working Zone window.*
 - 2) *The area accumulation for the Working Zone will be displayed in the Zone Ha window.*
 - 3) *The products assigned to the Bins for the selected Working Zone will be displayed in the Product and Bin Capacity windows*
- Press ENTER to accept the change

7.6 SWITCH A BIN ON or OFF

The Bin switches turn individual Bins ON or OFF; down is ON

- To turn a Bin ON. *Adjust the Bin switch (Bin 1, Bin 2, Bin 3 or Bin 4) for the selected bin to the down (ON) position.*
- To turn a Bin OFF. *Adjust the Bin switch (Bin 1, Bin 2, Bin 3 or Bin 4) for the selected bin to the up (OFF) position.*

The red LED aligned under each BIN switch, indicates the status of each Product (BIN). When the LED light is:

- **OFF** - The Bin Switch for that bin is switched OFF, temporarily.
- **Flashing**- Bin Switch is switched ON but not metering. MASTER is OFF
- **ON**- The Bin Switch is switched ON, MASTER is ON and Product is being metered at the calibrated sowing rate which is displayed "live" as the Application Rate.

7.7 DISPLAY SOWING RATES (WITH MASTER OFF)

- Press either LINE 1,2,3 or 4 buttons momentarily
- The current sowing rates will be displayed for all BINS, for about 3 seconds. After 3 seconds it reverts back to the live rates.

7.8 INCREASE OR DECREASE THE SOWING RATE OF A BIN

Note: When the 'RATE 1' application rate is not being dispensed for a selected bin then a red led will turn ON, aligned with that product. With the red led turned OFF this indicates to the operator that 'RATE 1' is being applied for that BIN.

- Press LINE 1, 2, 3 or 4 to select the bin you wish to adjust. *The BIN selected will be highlighted*
- Press the INC button to INCREASE the sowing rate, by the increment set for the product and bin
- OR
- Press the DEC button to DECREASE the sowing rate, by the increment set for the product and bin
- If the BIN is switched OFF, the rate will be displayed for approximately 3 seconds

7.9 SETTING RATE 1 OR RATE 2 FOR EACH BIN

Note: When the 'RATE 1' application rate is not being dispensed for a selected bin then a red led will turn ON, aligned with that product. With the red led turned OFF this indicates to the operator that 'RATE 1' is being applied for that BIN.

The RATE 1 button sets the PRESET SOWING RATE 1 for the highlighted Bin.
The RATE 2 button sets the PRESET SOWING RATE 2 for the highlighted Bin.

In the PRODUCT SETUP screen (Section 4.1) , part of the setup process for each PRODUCT is to set a PRESET RATE 1 and PRESET RATE 2 with a corresponding Bin number.

To select a PRESET RATE for each Bin:

- Press LINE 1 button to highlight Bin 1.
- Press the RATE 1 or RATE 2 button. The preset rate will be displayed in the LINE 1 window. If stationary, the rate will be displayed for 3 seconds. If seeding, the rate displayed will be the 'live' rate being metered out.
- Press LINE 2 button to highlight Bin 2.
- Press the RATE 1 or RATE 2 button. The LED next to either the RATE 1 or RATE 2 button will illuminate and the preset rate will be displayed in the LINE 2 window. If stationary, the rate will be displayed for 3 seconds. If seeding, the rate displayed will be the 'live' rate being metered out.

Repeat the above procedure to set a RATE 1 or RATE 2 for all remaining bins

7.10 BEGIN SEEDING

- Select a Working Zone
- Electronically REFILL any BINS
- Ensure any required BINS are switched ON. *The corresponding LED,s for the BINS that are switched ON will be flashing.*
- Switch Spray Pump ON. (Liquid Only)
- Engage the FAN
- Switch the MASTER switch to the ON position
- Drive OFF

7.11 RETURN TO A PRESET RATE 1 OR RATE 2

During seeding the operator may have used the INC or DEC buttons to change the sowing rate for a particular Bin. The following shows how to bring a particular Bin back to either a PRESET RATE 1 or RATE 2.

- Press LINE 1, LINE 2, LINE 3 OR LINE 4 to highlight the Bin to be adjusted
- Press the RATE 1 or RATE 2 button. The PRESET RATE (1or2) will be displayed in the highlighted Bin window.

7.12 USE THE MANUAL SPEED

- Press the PRIME/MANUAL button
- MANUAL will be displayed in the 'Speed Window' and the manual speed set, will be displayed.
- To switch MANUAL SPEED OFF, press the PRIME/MANUAL button once and the LED will turn off.
- The current groundspeed will be displayed

7.13 DISPLAY ACTUATOR POSITION

- With the MASTER switch ON
- Press the MENU button. *In the Product and Bin Capacity windows, for granular selected products; the Bin Capacity weight will be replaced by an Actuator Position displayed as a (%). This will give the operator an indication given the current application for the Bin, how the operator can increase the application rate.*
- Press the MENU button again to return to normal screen.

7.14 DISPLAY PUMP (RPM) AND LIQUID PRESSURE (Liquid Only)

- With the MASTER switch ON
- Press the MENU button. *The Spray Pump (rpm) will be displayed where the Fan Speed was normally displayed. The Liquid Pressure (kpa) will be displayed where the Fan Pressure was normally displayed.*
- Press the MENU button again to return to normal screen.

7.15 ADJUST BRIGHTNESS OF THE CONSOLE SCREEN

At the back left-hand side of the Console is a metal adjusting knob, turn the knob clockwise or anti-clockwise to adjust brightness of the screen to suit. See Section 14.1 for position of Contrast Knob.

8.0 LIQUID SETUP

This section explains the setting up of one or two liquid tanks for the Simplicity Console.



Working Screen with a Liquid Tank

8.1 Simplicity Console Liquid Setup

Overview

The Simplicity Seed Rate Controller is designed to also control up to '2' Liquid Channels. The principles of control are identical to a conventional spraying system with one main difference; only one section is used as opposed to multiple sections on some sprayers.

The Simplicity Liquid Control is a flow based system where the controller monitors Speed, Flow Rate, and Target rate and adjusts pressure via the Pressure Regulator Valve to maintain application rate to the Ground. An increase in speed or rate will result in the controller increasing pressure to maintain correct target rate, similarly a reduction in speed or rate results in the pressure being reduced to maintain target rate.

The Control Valve Set is designed to allow the widest possible application rate range within the limitations of the nozzles being used. The system also delivers liquid to a "Hydraulic Agitator" fitted to the bottom of the liquid tank. This helps keep tank mixes in suspension to avoid settling that may result in blockages.

Agitation Circuit

As mentioned above a "Hydraulic Agitator" is used to constantly turn over the tank contents to limit the settling of tank mixed chemicals and fertilizers. The agitator requires delivery of flow at no less than 500kpa, optimum being 600-700kpa. At this pressure range the agitator will use around 15-20Lpm to turnover 600-700Lpm of tank volume. To achieve this, the pump output (126Lpm @ 540rpm) is directed to a Priority Valve (PV). This is set to direct the required pressure and flow to the Agitator, and bypasses the unused flow to the Control Set. This ensures that agitation remains constant regardless of the Control Set pressure which will usually be anywhere within the range of 100-500kpa.

Control Set (CS)

The control set is made up of the following components:

1. Pressure Relief/Dump Valve

This valve has a dual function. Function 1: System Safety Valve. The pressure relief should be set just above the highest application pressure, usually 400-500kpa. Function 2: Dump facility that bypasses all of the flow to tank when the Master Switch is switched OFF. (The ON/OFF valve will be closed when the Dump is open)

2. Pressure Regulator Valve (PRV)

The PRV controls the application rate to the ground. It does this by returning flow that is not required on the ground to the tank. If the application rate is higher than needed the valve opens allowing more bypass and if rate is lower, closes to reduce bypass and directing more flow to the ground.

3. Flowmeter

The Flowmeter measures the amount of liquid applied to the ground. The controller monitors this flow (actual) and compares it to the Calculated (Set) rate. If there is a difference an adjustment is made by either opening or closing the PRV.

4. On/Off Valve

This valve simply stops or starts the flow to the ground. When this valve opens the dump valve closes and vice versa.

8.2 Liquid Control Setup

Before accurate application rate control can be achieved on any liquid system the 'Control Set' MUST be set and CONFIRMED Manually.

Note: This is not a Flowmeter calibration. It is only to verify the correct operation of the system. Flowmeter calibration is explained later in this section.

ACCURATE APPLICATION IS DEPENDENT ON THE CORRECTLY SELECTED NOZZLES FOR THE TASK. DO NOT PROCEED UNTIL THE CORRECT NOZZLES ARE INSTALLED.

Calculate the desired application rate and pressure for your application. This will determine what size nozzles are to be used. The formula below will help attain these details.

$$\text{Target Rate} \times \text{Width} \times \text{Speed} / 600 / \text{Number of Nozzles} = \text{Lpm per nozzle.}$$

Reference the LPM and pressure using the correct nozzle chart to determine the correct nozzle or orifice plate size.

Do not continue setup until correct nozzles are installed.

Steps:

- 1- Add water to the tank. Ensure enough water to completely cover the agitator, approximately 500lts.
- 2- Ensure the Priority and Pressure Relief valves are both adjusted to deliver at their lowest pressure. (Turn anti-clockwise to achieve this)

8.3 LIQUID TANK SETUP '1' SCREEN

See Section 3.1.4 to set up DRIVE 3 and/or DRIVE 4 as a LIQUID channel.

- Press MENU
- Press ENTER to advance to SEEDER SETUP screen
- Press LINE 1 to highlight BIN SETUP
- Press ENTER to advance to BIN SETUP
- Press LINE 1 to highlight LIQUID TANK SETUP
- Press ENTER to advance to LIQUID TANK SETUP 1 screen

Single Liquid Tank Selected

Note: When a single Liquid Tank is selected, then either a '(4)' or '(3)' will appear next to each option depending which tank was selected as the Liquid tank. In the screen below the 4th channel has been set up as a Liquid Drive. Only Drives '3' or '4' can selected and setup as Liquid Tanks.

Two Liquid Tanks Selected

When both 'Drive 3' and 'Drive 4' have been set up as Liquid channels in 'Bin Setup' Section 3.1. If a '(3)' is displayed next to the options then 'Liquid Tank 3' is being setup. Setup all the options from 8.3.1 to 8.3.13, for 'Liquid Tank 3' To setup the 'Liquid Tank 4' PRESS the RESET button on either the 'Liquid Tank Setup 1' or 'Liquid Channel Setup 2' screen. The options will now display '(4)' after all the options. Then setup all the options from 8.3.1 to 8.3.13 for the 'Liquid Tank 4'.

Press the RESET button on either the 'Liquid Tank Setup 1' or 'Liquid Tank Setup 2' screen this will alternate between 'Tank 3' or 'Tank 4' setup screens.



Liquid Tank Setup 1 Screen

8.3.1 SET THE CONTROL MODE

Note: This setting is selecting the type of regulator valve installed in the Control Set. When the type of regulator valve is selected, the defaults are automatically set for: "MAX ON TIME (4)", "MIN ON TIME (4)", "GAIN SETTING (4)" and "PWM SETTING"(4). There should be no need to alter these defaults settings unless instructed by a Simplicity Service Person. If the regulator valve being used is not listed then select "STANDARD". By default Simplicity uses the STANDARD type.

Standard Types: Arag Type, KEE Type, Hardi type Reg Valves

Raven: Raven Fast Reg. Valves

Micro-Track: Micro-Track Reg. Valves

Dickey-John: Dickey John Reg. Valves

- Press MENU
- Press ENTER to advance to SEEDER SETUP screen
- Press LINE 1 to highlight BIN SETUP
- Press ENTER to advance to BIN SETUP
- Press LINE 1 to highlight LIQUID TANK SETUP
- Press ENTER to advance to LIQUID TANK SETUP 1 screen
- Press ENTER to edit CONTROL MODE. An asterisk (*) will appear.
- Press INC/DEC buttons to select between: STANDARD, RAVEN, DICKEY-J (Dickey-John) and M-TRACK (Mirco-Track)
- Press ENTER to accept the changes

8.3.2 SET THE FLOWMETER SENSITIVITY

Note: DeFault is STANDARD

- Press MENU
- Press ENTER to advance to SEEDER SETUP screen
- Press LINE 1 to highlight BIN SETUP
- Press ENTER to advance to BIN SETUP
- Press LINE 1 to highlight LIQUID TANK SETUP
- Press ENTER to advance to LIQUID TANK SETUP 1 screen
- Press LINE 1, until the focus is on FLOWMETER SENSITIVITY
- Press ENTER to edit FLOWMETER SENSITIVITY. *An asterisk (*) will appear.*
- Press INC/DEC buttons, to select between STD and LOW
- Press ENTER to accept the changes

8.3.3 SET THE MAX ON TIME

Depending on the type of regulator valve selected in Section 8.3.1, will determine what range of values in (mS) are available, there are four values to select from.

- Press MENU
- Press ENTER to advance to SEEDER SETUP screen
- Press LINE 1 to highlight BIN SETUP
- Press ENTER to advance to BIN SETUP
- Press LINE 1 to highlight LIQUID TANK SETUP
- Press ENTER to advance to LIQUID TANK SETUP 1 screen
- Press LINE 2, till the focus is on MAX ON TIME
- Press ENTER to edit MAX ON TIME. *An asterisk (*) will appear.*
- Press INC/DEC buttons to select a value.
- Press ENTER to accept the changes

8.3.4 SET THE MIN ON TIME

Depending on the type of regulator valve selected in Section 8.3.1, will determine what range of values in (mS) are available, there are four values to select from.

- Press MENU
- Press ENTER to advance to SEEDER SETUP screen
- Press LINE 1 to highlight BIN SETUP
- Press ENTER to advance to BIN SETUP
- Press LINE 1 to highlight LIQUID TANK SETUP
- Press ENTER to advance to LIQUID TANK SETUP 1 screen
- Press LINE 2, till the focus is on MIN ON TIME
- Press ENTER to edit MIN ON TIME. *An asterisk (*) will appear.*
- Press INC/DEC buttons to select a value.
- Press ENTER to accept the changes

8.3.5 SET THE GAIN SETTING

Depending on the type of regulator valve selected in Section 8.3.1, will determine what range of values in (mS/%) are available, there are four values to select from.

- Press MENU
- Press ENTER to advance to SEEDER SETUP screen
- Press LINE 1 to highlight BIN SETUP
- Press ENTER to advance to BIN SETUP
- Press LINE 1 to highlight LIQUID TANK SETUP
- Press ENTER to advance to LIQUID TANK SETUP 1 screen
- Press LINE 3, the focus is on GAIN SETTING
- Press ENTER to edit GAIN SETTING. *An asterisk (*) will appear.*
- Press INC/DEC buttons to select a value.
- Press ENTER to accept the changes

8.3.6 SET THE PWM SETTING

Depending on the type of regulator valve selected in Section 8.3.1, will determine what range of values in (%) are available, there are four values to select from.

- Press MENU
- Press ENTER to advance to SEEDER SETUP screen
- Press LINE 1 to highlight BIN SETUP
- Press ENTER to advance to BIN SETUP
- Press LINE 1 to highlight LIQUID TANK SETUP
- Press ENTER to advance to LIQUID TANK SETUP 1 screen
- Press LINE 3, the focus is on PWM SETTING
- Press ENTER to edit PWM SETTING. *An asterisk (*) will appear.*
- Press INC/DEC buttons to set the value.
- Press ENTER to accept the changes

8.3.7 SET CLOSE VALVE WHEN OFF

By Default 'CLOSE VALVE WHEN OFF ' is OFF.

- Press MENU
- Press ENTER to advance to SEEDER SETUP screen
- Press LINE 1 to highlight BIN SETUP
- Press ENTER to advance to BIN SETUP
- Press LINE 1 to highlight LIQUID TANK SETUP
- Press ENTER to advance to LIQUID TANK SETUP 1 screen
- Press LINE 4, until the focus is on CLOSE VALVE WHEN OFF
- Press ENTER to edit CLOSE VALVE WHEN OFF. *An asterisk (*) will appear.*
- Press INC/DEC buttons to select between, ON or OFF
- Press ENTER to accept the changes

8.3.8 SET VALVE REVERSE

Note: The Valve Reverse only has to be selected ON if the Regulator Valve is opening and closing in the wrong direction. Default is OFF.

- Press MENU
- Press ENTER to advance to SEEDER SETUP screen
- Press LINE 1 to highlight BIN SETUP
- Press ENTER to advance to BIN SETUP
- Press LINE 1 to highlight LIQUID TANK SETUP
- Press ENTER to advance to LIQUID TANK SETUP 1 screen
- Press LINE 4, until the focus is on VALVE REVERSE)
- Press ENTER to edit VALVE REVERSE. *An asterisk (*) will appear.*
- Press INC/DEC to select the VALVE REVERSE, ON or OFF
- Press ENTER to accept the changes

8.3.9 LIQUID TANK SETUP '2' SCREEN

- Press MENU
- Press ENTER to advance to SEEDER SETUP screen
- Press LINE 1 to highlight BIN SETUP
- Press ENTER to advance to BIN SETUP
- Press LINE 1 to highlight LIQUID TANK SETUP
- Press ENTER to advance to LIQUID TANK SETUP 1 screen
- Press MENU to advance to LIQUID TANK SETUP 2 screen

Note: The '(4)' next to each option indicates which Drive the Liquid Tank is being set up for. In this case the 4th Tank is being set up as a Liquid Drive.

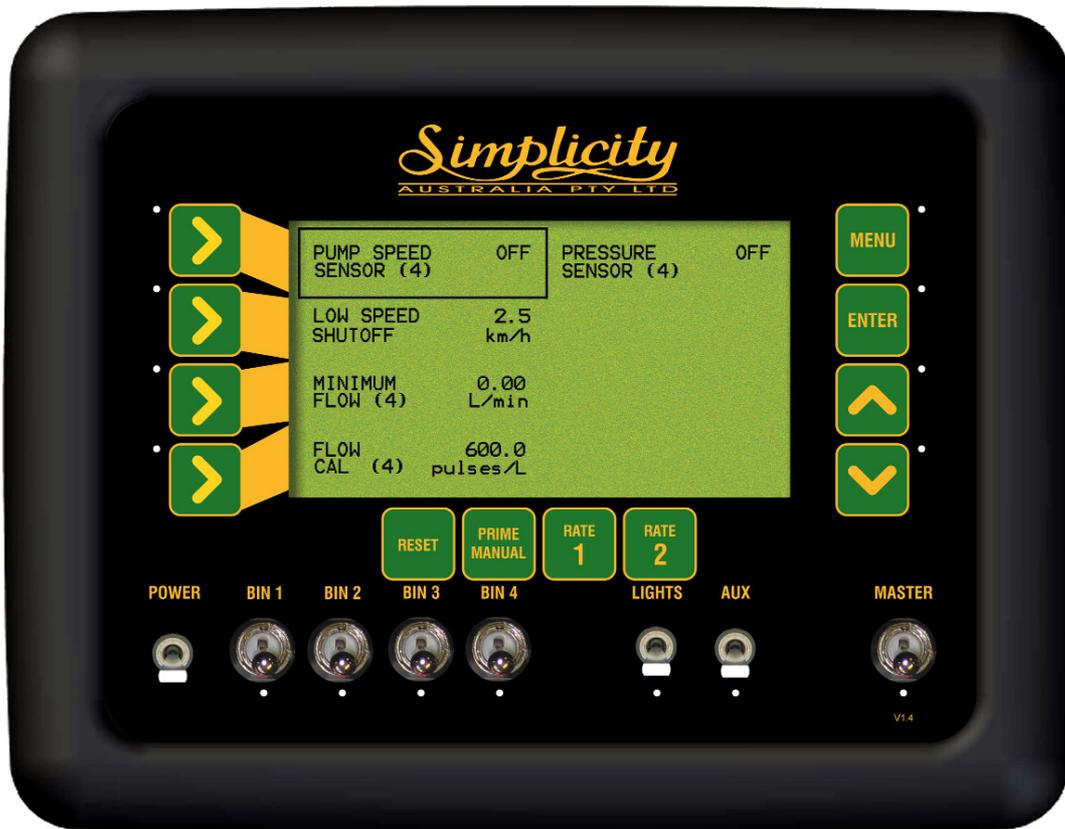

Liquid Tank Setup 2 Screen

8.3.10 SET THE PUMP SPEED SENSOR

Note: Select ON if a shaft sensor kit is fitted to the plug marked "PUMP SPEED" on the Sprayer Harness. This will enable PUMP SPEED SENSOR alarms to be enabled, in LIQUID ALARMS SETUP

- Press MENU
- Press ENTER to advance to SEEDER SETUP screen
- Press LINE 1 to highlight BIN SETUP
- Press ENTER to advance to BIN SETUP
- Press LINE 1 to highlight LIQUID TANK SETUP
- Press ENTER to advance to LIQUID TANK SETUP 1 screen
- Press MENU to advance to LIQUID TANK SETUP 2 screen
- Press ENTER to edit the PUMP SPEED SENSOR
- Press INC/DEC buttons, to select ON or OFF
- Press ENTER to accept changes

8.3.11 SET THE LOW SPEED SHUTOFF

By Default the LOW SPEED SHUTOFF is set 2.5km/hr

To turn the 'LOW SPEED SHUTOFF' OFF set a value of '0.0'

- Press MENU
- Press ENTER to advance to SEEDER SETUP screen
- Press LINE 1 to highlight BIN SETUP
- Press ENTER to advance to BIN SETUP
- Press LINE 1 to highlight LIQUID TANK SETUP
- Press ENTER to advance to LIQUID TANK SETUP 1 screen
- Press MENU to advance to LIQUID TANK SETUP 2 screen
- Press LINE 2 to highlight LOW SPEED SHUTOFF
- Press ENTER to edit the LOW SPEED SHUTOFF
- Press INC/DEC buttons, to set a value.
- Press ENTER to accept changes

8.3.12 SET THE MINIMUM FLOW

Most Regulator valves can only control down to a set (Litres/minute), under this value the regulator valve may not be able to control the application rate as effectively; as a value above the Minimum Flow value. The Minimum Flow value can be found with the Regulator Valves specifications. Use this value if a Minimum Flow Value is going to be set.

To turn OFF the Minimum Flow value, set a value of '0.0'

- Press MENU
- Press ENTER to advance to SEEDER SETUP screen
- Press LINE 1 to highlight BIN SETUP
- Press ENTER to advance to BIN SETUP
- Press LINE 1 to highlight LIQUID TANK SETUP
- Press ENTER to advance to LIQUID TANK SETUP 1 screen
- Press MENU to advance to LIQUID TANK SETUP 2 screen
- Press LINE 3 to highlight MINIMUM FLOW
- Press ENTER to edit the MINIMUM FLOW
- Press INC/DEC buttons, to set a value.
- Press ENTER to accept changes

8.3.13 PRESSURE SENSOR SETUP

By default an electronic 'Pressure Sensor' is fitted to the Simplicity Control Set. Select ON if a electronic 'Pressure Sensor' is fitted to the Liquid Tank. When the 'Pressure Sensor' is selected ON, then three (3) extra options will appear on the 'Liquid Tank 2 Setup' screen. See Sections 8.3.14; 8.3.15 and 8.3.16. to continue setup.

Note: If two (2) liquid tanks are selected; then only one (1) of the Liquid Tanks (3 or 4) can have a 'electronic Pressure Sensor' connected to it. So when a 'Pressure Sensor is selected ON for example 'Tank 3'; then the 'Pressure Sensor' for 'Tank 4' cannot be selected.

- Press MENU
- Press ENTER to advance to SEEDER SETUP screen
- Press LINE 1 to highlight BIN SETUP
- Press ENTER to advance to BIN SETUP
- Press LINE 1 to highlight LIQUID TANK SETUP
- Press ENTER to advance to LIQUID TANK SETUP 1 screen
- Press MENU to advance to LIQUID TANK SETUP 2 screen
- Press LINE 1 twice to highlight PRESSURE SENSOR
- Press ENTER to edit the PRESSURE SENSOR
- Press INC/DEC buttons, to set the PRESSURE SENSOR ON or OFF
- Press ENTER to accept changes

Note: The Flow Calibration for the Flow meter will be entered later, in the Liquid Setup. (Section 8.6).

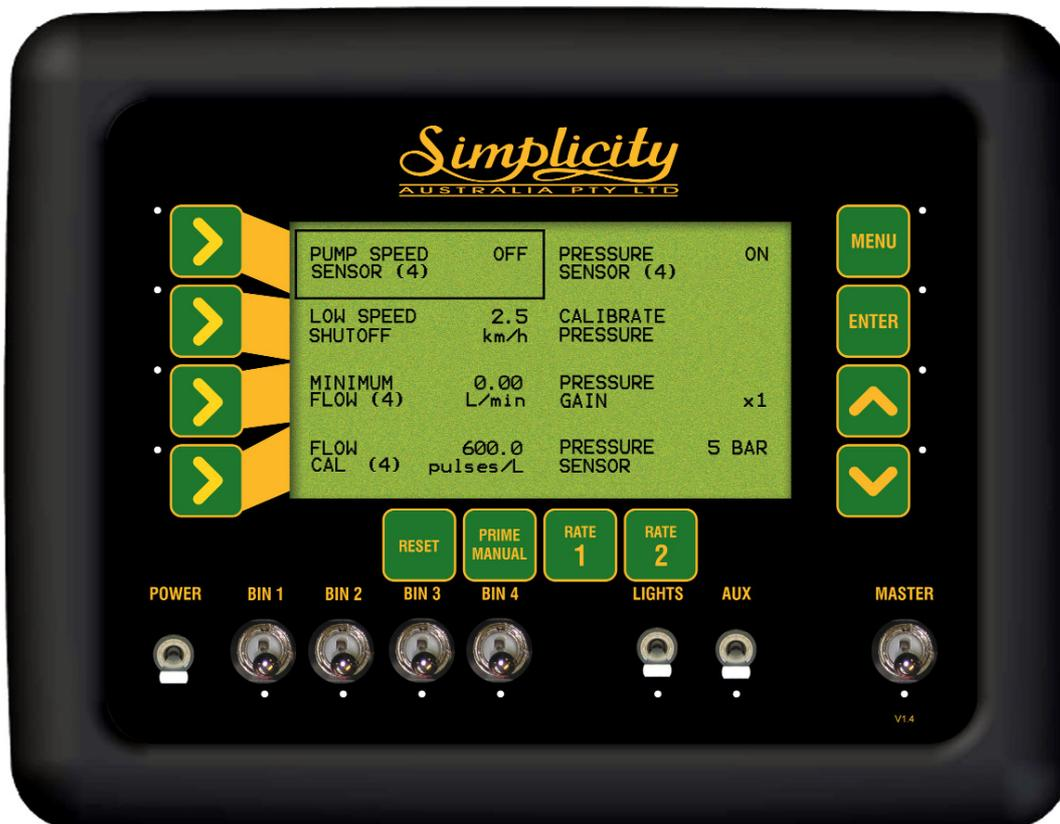

Liquid Tank Setup '2' Screen
(with Pressure Sensor 'ON')

8.3.14 SET PRESSURE GAIN

- Press MENU
- Press ENTER to advance to SEEDER SETUP screen
- Press LINE 1 to highlight BIN SETUP
- Press ENTER to advance to BIN SETUP
- Press LINE 1 to highlight LIQUID TANK SETUP
- Press ENTER to advance to LIQUID TANK SETUP 1 screen
- Press MENU to advance to LIQUID TANK SETUP 2 screen
- Press LINE 1 twice to highlight PRESSURE SENSOR
- Press ENTER to edit the PRESSURE SENSOR
- Press INC/DEC buttons, to set the PRESSURE SENSOR ON
Note: When the 'Pressure Sensor' is set ON; extra screen options become available.
- Press LINE 3 twice to highlight PRESSURE GAIN
- Press ENTER to edit PRESSURE GAIN.
An asterisk () will appear.*
- Press INC/DEC buttons to select between x1 or x2. Default is 'X1'
Note: 'x1' Fan Pressure Gain is the default setting for Simplicity Actuator Consoles with software version 2.0.0 or later and connected to a MDECU X2 Pressure Gain should only be selected if directed by a KEE Service Representative depending on the Simplicity console hardware fitted to your air seeder .
- Press ENTER to accept changes

8.3.15 SET PRESSURE SENSOR TYPE

- Press MENU
- Press ENTER to advance to SEEDER SETUP screen
- Press LINE 1 to highlight BIN SETUP
- Press ENTER to advance to BIN SETUP
- Press LINE 1 to highlight LIQUID TANK SETUP
- Press ENTER to advance to LIQUID TANK SETUP 1 screen
- Press MENU to advance to LIQUID TANK SETUP 2 screen
- Press LINE 1 twice to highlight PRESSURE SENSOR
- Press ENTER to edit the PRESSURE SENSOR
- Press INC/DEC buttons, to set the PRESSURE SENSOR ON or OFF
- Press ENTER to accept changes
- Press LINE 1 twice to highlight PRESSURE SENSOR
- Press ENTER to edit the PRESSURE SENSOR
- Press INC/DEC buttons, to set the PRESSURE SENSOR ON
Note: When the 'Pressure Sensor' is set ON; extra screen options become available.
- Press LINE 4 twice to highlight PRESSURE SENSOR
- Press ENTER to edit PRESSURE SENSOR.
An asterisk () will appear.*
- Press INC/DEC buttons to select between 5 BAR or 10 BAR.
The Pressure Sensor connected to the Simplicity Liquid Tank by default is '5 BAR', and there should not have to be changed. If a '10 BAR Pressure Sensor' is fitted then select '10 BAR'
- Press ENTER to accept changes

8.3.16 CALIBRATE PRESSURE SENSOR

Note: A "Glass Pressure Gauge" should be connected as close to the electronic pressure sensor as possible. The "Glass Gauge" will give the actual pressure, so the electronic pressure transducer can be calibrated.

- Press MENU
- Press ENTER to advance to SEEDER SETUP screen
- Press LINE 1 to highlight BIN SETUP
- Press ENTER to advance to BIN SETUP
- Press LINE 1 to highlight LIQUID TANK SETUP
- Press ENTER to advance to LIQUID TANK SETUP 1 screen
- Press MENU to advance to LIQUID TANK SETUP 2 screen
- Press LINE 1 twice to highlight PRESSURE SENSOR
- Press ENTER to edit the PRESSURE SENSOR
- Press INC/DEC buttons, to set the PRESSURE SENSOR ON

Note: When the 'Pressure Sensor' is set ON; extra screen options become available.

- Press LINE 2 twice to highlight CALIBRATE PRESSURE
- Press ENTER to advance to CALIBRATE PRESSURE screen
The CALIBRATE PRESSURE SENSOR screen will be displayed with the focus on TURN PUMP OFF
- Press ENTER
- *Ensure the Spray Pump is turned OFF.*
- Press ENTER. *The focus window will move to the next window IS PUMP OFF? then Press ENTER, at this point the Eagle console is taking a zero point for the electronic pressure sensor while the pump is turned OFF.*
- *Turn the pump on the liquid tank ON, and take the pump up to operating pressure, once at operating pressure...*
- Press ENTER *the focus window will move to IS PUMP AT OPERATING PRESS? Reminding the operator to have the liquid tank pump at operating pressure.*
- Press ENTER again to move the focus window to ACTUAL PRESSURE.
- Press ENTER to edit the ACTUAL PRESSURE. *An asterisk (*) will appear.*
- Press the INC/DEC buttons, till the value in the ACTUAL PRESSURE window; is the same as read by the "Glass Pressure Gauge"
The CALCULATED PRESSURE window displays the Calculated Pressure reflecting the current calibration for the electronic pressure sensor, this value can not be changed.
- Press ENTER to accept the new pressure calibration factor for the electronic pressure sensor.
- Press the DEC button to return to the previous screen.

8.4 SETTING UP A PRODUCT FOR A LIQUID TANK

For each liquid product that is going to be sown, similar to setting up for a granular product, it is necessary to enter the following;

1. Product Name (See Section 4.1.1)
2. Bin Number (See Section 4.1.2, Enter Liquid Drive Number)
3. Density of the Product (See Section 4.1.4)
4. Preset Sowing Rate 1 (Litres/Ha) (See Section 4.1.5)
5. Preset Sowing Rate 2 (Litres/Ha) (See Section 4.1.6)
6. Sowing Rate Increment/Decrement (Litres/Ha) (See Section 4.1.7)
7. Calibration Factor (the current Flow Calibration Factor is displayed on the PRODUCT SETUP Screen but must be calibrated, See Section 8.3.13 to calibrate the flow meter)

Once the liquid product has been set up return to the 'Working Screen' by repeatedly pressing the DEC button.

8.5 SETTING UP THE PUMP

- To view 'Pump Speed'
 - 1- Press MENU when the 'Liquid Tank' Switch and the Master Switch are ON.
 - 2- Control Set pressure will also be displayed.
 - 3- Switch OFF the 'Liquid Tank' Switch and 'Master' Switch
- Start the Liquid Pump (Ensure the Manual flow control on the tractor is set to minimum before engaging pump)
- Using the "Pump speed" readout increase the pump speed to 350-400rpm. (Unless extremely high rates and pressure are required the pump will not need to exceed this speed). Note: over speed of the pump will result in a smaller control range as the lower pressures/rates will not be attainable without changes to the Control Set.
- Slowly wind the Priority valve clockwise until the Agitation Pressure increases to 600kpa. This sets the agitation pressure and should not require further adjustment.
- Turn ON the override Switch on the 'Liquid Panel' (up = override). This will Close the Dump valve, Open the ON/OFF valve and fully close the Pressure Regulator valve. At this point there will be little or no pressure showing on the CS Gauge on the 'Liquid Panel'.
- Slowly wind the Pressure Relief valve clock-wise until the pressure rises to your maximum required operating pressure, usually 400-500kpa. (This is determined by your nozzle choice. Refer to Nozzle chart)
- Turn override switch OFF. The CS pressure will drop to almost '0'. This confirms the Dump valve is working correctly.

8.6 SET THE FLOW CALIBRATION FACTOR

- Press MENU
 - Press ENTER to advance to SEEDER SETUP screen
 - Press LINE 1 to highlight BIN SETUP
 - Press ENTER to advance to BIN SETUP
 - Press LINE 1 to highlight LIQUID TANK SETUP
 - Press ENTER to advance to LIQUID TANK SETUP 1 screen
 - Press MENU to advance to LIQUID TANK SETUP 2 screen
 - Press LINE 4 to highlight FLOW CAL . *The focus window will display the current FLOW CAL factor in pulses/L. The number in brackets after 'FLOW CAL' represents the Liquid Tank number, the 'Flow Cal' value is displaying*
- Press ENTER. *Screen will advance to FLOW CAL SETUP screen. Go to Section 8.6.1 to continue setup using Automatic Flow Calibration method or go to Section 8.6.2 to manually enter the Flow Calibration which is located on the Flow Meter on the sprayer. The number located on the Flow Meter must be in "pulses per litre" (ppl), for the number to entered in manually.*

To set the 'Flow Cal' for another Liquid Tank if fitted. PRESS the RESET button, the number in the brackets will change to show the 'Flow Cal' value for the second liquid tank. Then go to Section 8.6.1 or 8.6.2 to enter a 'Flow Cal' value for the second liquid tank.



Flow Cal Screen

8.6.1 AUTOMATIC FLOW CALIBRATION

- Fully prime the flow sensor and hose
- Place a measuring jug under one (1) nozzle outlet.
- Press ENTER to begin flow factor calculation
- The valve will open and fluid will begin to pump through the manifold. *The pulse count will begin accumulating as you meter out liquid*
- Allow the 'Measuring Jug' to fill to the largest amount recordable. Multiply Volume by the number of nozzles, note this volume.
- Press ENTER; this will automatically close the 'Regulator Valve'. *The focus will automatically jump to ACTUAL FLOW line of the screen*
- Use INC/DEC buttons to change the volume, to reflect the actual volume collected in the 'Measuring Jug'.
- Press ENTER to accept the value. *The 'Flow Cal' factor will be automatically calculated and displayed.*
Pressing the 'Reset' button, during calibration will abort the calibration process

8.6.2 MANUAL FLOW CALIBRATION

If the Flow Meter has a 'Flow Cal' value stamped on the flow meter then that value can be entered in here. The value must be in "pulses per litre" (PPL).

- Press LINE 3 until the focus is on FLOW CAL(1)
- Press ENTER to edit the value
- Press INC/DEC buttons to change the FLOW CAL factor
- Press ENTER to accept the value

Note: Press DEC button to return to the previous Sprayer Setup Screen once the calibration is finished.

8.7 Confirming Control Circuit with New Settings

- Press the PRIME MANUAL, button (this will give you 10km/hr simulation Speed)
- Switch ON 'Liquid Tank' Switch and 'Master' Switch
Controller will adjust the pressure to maintain the Application rate set earlier, disregard readings at this point.

8.8 Confirming the Minimum and Maximum Rate at the Manual Speed

- Press SELECT 4 (for Bin/Tank 4) or SELECT 3 (for Bin/Tank 3) Liquid Channel
- Press INC to increase the rate. Keep increasing the rate until the Maximum available pressure is reached. This will be equal to the Pressure reached earlier in the Control Set Setup.
- Press DEC to 'decrease the rate'. Keep decreasing the rate until the Min Pressure is reached. The minimum pressure is shown on the Nozzle chart. It will usually be around 100kpa.
If the pressure shown is above the required minimum reduce the pump speed until the required pressure is attained.

The Control Set and Controller Calibration is now complete.

Note: GREAT CARE HAS BEEN TAKEN WITH THE CONTROL SET TO ACHIEVE THE WIDEST POSSIBLE CONTROL RANGE AND PROPER AGITATION. ENSURE THAT YOUR NOZZLES ARE CORRECT FOR YOUR APPLICATION AS INCORRECT NOZZLES WILL LIMIT THE PERFORMANCE OF THE SYSTEM AND YOUR LIQUID APPLICATION WILL NOT BE SUCCESSFUL.

9.0 CONFIGURATION OPTIONS

To access the extra console related 'Configuration Options', hold down the RESET button while the console, is starting up using the POWER switch. Then the Configuration Menu screen will be displayed.

- To advance to the GENERAL CONFIG see Section 9.3
- To advance to the KEY CONFIG see Section 9.1
- To advance to the ALARM CONFIG see Section 9.2



Configuration Menu

9.1 KEY CONFIGURATION

- Press LINE 2 to highlight KEY CONFIG
- Press ENTER to advance KEY CONFIGURATION screen



Key Configuration Screen

9.1.1 SWITCH THE KEY BEEPER ON/OFF

- Press LINE 2 to highlight KEY CONFIG
- Press ENTER to advance KEY CONFIGURATION screen
- Press ENTER to edit the KEY BEEPER. *An asterisk (*) will be displayed*
- Press INC/DEC buttons to switch the beeper state ON or OFF
- Press ENTER to accept changes

The KEY BEEPER when switched ON will mean every time the key buttons on the console are pressed a beep will sound. When switched OFF, there is no beep when the key is pressed.

9.1.2 CHANGE THE KEY BEEPER TIME

- Press LINE 2 to highlight KEY CONFIG
- Press ENTER to advance KEY CONFIGURATION screen
- Press LINE 2 to highlight KEY BEEPER TIME
- Press ENTER to edit KEY BEEPER TIME. *An asterisk (*) will be displayed*
- Press INC/DEC buttons to edit the beeper time
- Press ENTER to accept changes

When the KEY BEEPER is toggled ON, then the KEY BEEPER TIMER determines how long the beep sound lasts for. The default is 300mS which is a third of a second.

9.1.3 SWITCH THE KEY REPEAT ENABLED

- Press LINE 2 to highlight KEY CONFIG
- Press ENTER to advance KEY CONFIGURATION screen
- Press LINE 3 to highlight KEY REPEAT ENABLE
- Press ENTER to edit KEY REPEAT ENABLE. *An asterisk (*) will be displayed*
- Press INC/DEC buttons to switch the key beeper, ON or OFF.
- Press ENTER to accept changes

The KEY REPEAT ENABLED when toggled ON allows the operator when using the Inc/Dec buttons to change values on the console during setup; to hold the Inc or Dec button down and the value will change without having to continually press the button to change the value. When switched OFF the operator will have to repeatedly press the Inc or Dec buttons to change the value.

9.1.4 ADJUST THE KEY REPEAT DURATION

- Press LINE 2 to highlight KEY CONFIG
- Press ENTER to advance KEY CONFIGURATION screen
- Press LINE 4 to highlight the KEY REPEAT DURATION
- Press ENTER to edit the KEY REPEAT DURATION *An asterisk(*) will be displayed*
- Press INC/DEC buttons to set the KEY REPEAT DURATION
- Press ENTER to accept changes

When the KEY BEEPER ENABLED is toggled ON, the KEY REPEAT DURATION determines how long when the Inc or Dec button is held down how quickly the value changes. The default is 300mS.

9.2 ALARM CONFIGURATION

- Press LINE 3 to highlight ALARM CONFIG
- Press ENTER to advance to the ALARM CONFIGURATION screen



Alarm Configuration Screen

9.2.1 Alarm Beeper Overview-

- This screen allows to change the settings on how the alarm will beep when an alarm appears in the ALARM WINDOW on the Working Screen.
- The ALARM CYCLE TIME sets how long in milliseconds (mS) the alarm stays in the ALARM WINDOW.
- The ALARM CYCLES is how many times the alarm will cycle (beep and flash, in the 'Alarm Window'
- The ALARM DUTY CYCLE is the percentage of time the beeper will beep, when the alarm is flashing in the 'Alarm Window'. Ie. When the ALARM DUTY CYCLE is set at 50% the beep will sound for half the time (50%), the alarm flashes in the 'Alarm Window.' The ALARM BEEPER needs to be switched ON.
- The ALARM BEEPER can be switched ON or OFF. When the beeper is turned ON, the console will beep as well as display what the alarm is. When the beeper is turned OFF, the alarm will be displayed on the screen but without the beep
- Ie. The default settings are displayed on the screen on Page 53.
- The alarm will appear in the ALARM WINDOW.
- The alarm will flash for 1 second.
- The alarm will beep for 1/2 a second (50% of the alarm cycle time), and the alarm will cycle (flash and beep) 5 times.
- After the 5 cycles the beep will stop and if the alarm is still present, then the alarm will cycle through in the ALARM WINDOW with no beep.

9.2.2 SET THE ALARM CYCLE TIME

- Press LINE 3 to highlight ALARM CONFIG
- Press ENTER to advance to the ALARM CONFIGURATION screen
- Press ENTER to edit the ALARM CYCLE TIME.
An asterisk () will be displayed*
- Press INC/DEC button to set the ALARM CYCLE TIME
- Press ENTER to accept changes

9.2.3 SET THE ALARM DUTY CYCLE

- Press LINE 3 to highlight ALARM CONFIG
- Press ENTER to advance to the ALARM CONFIGURATION screen
- Press LINE 2 to highlight ALARM DUTY CYCLE
- Press ENTER to edit the ALARM DUTY CYCLE.
An asterisk () will be displayed*
- Press INC/DEC buttons to set the ALARM DUTY CYCLE
- Press ENTER to accept changes

9.2.4 SET THE NUMBER OF ALARM CYCLES

- Press LINE 3 to highlight ALARM CONFIG
- Press ENTER to advance to the ALARM CONFIGURATION screen
- Press LINE 3 to highlight ALARM CYCLES
- Press ENTER to edit the ALARM CYCLES.
An asterisk () will be displayed*
- Press INC/DEC buttons to set the number of ALARM CYCLES
- Press ENTER to accept changes

9.2.5 SWITCH THE ALARM BEEPER ON/OFF

- Press LINE 3 to highlight ALARM CONFIG
- Press ENTER to advance to the ALARM CONFIGURATION screen
- Press LINE 4 to highlight ALARM BEEPER
- Press ENTER to edit the ALARM BEEPER. *An asterisk (*) will be displayed*
- Press INC/DEC to toggle alarm beeper ON or OFF
- Press ENTER to accept changes

9.3 GENERAL CONFIGURATION

- Press LINE 1 to select GENERAL CONFIG
- Press ENTER to select GENERAL CONFIG
- See the following page for details on the General Configuration screen

Note: The 'General Configuration' screen below is what the screen should look like when the Simplicity Console is set up for a 'Actuator' controller.



General Configuration Screen

9.3.1 CHANGING BETWEEN AIR SEEDER MONITOR AND SEED RATE

CONTROLLER

- Press ENTER to select GENERAL CONFIG
- Press ENTER to change UNIT TYPE. *An asterisk (*) will be displayed*
- Press INC/DEC buttons to switch between SRC (Seedrate control) and ASM (Area, shaft monitor).

SRC MUST BE SELECTED FOR ACTUATOR DRIVE MODELS

- Press ENTER to accept the changes

9.3.2 INTERFACE TO AN MDECU: (ACTUATOR DRIVE ONLY)

- Press ENTER to select GENERAL CONFIG
- Press LINE 2 to highlight INTERFACE TO MDECU
- Press ENTER to edit INTERFACE TO MDECU.
An asterisk () will be displayed*
- Press INC/DEC buttons to switch between ON or OFF

ON MUST BE SELECTED FOR ACTUATOR DRIVE MODELS

- Press ENTER to accept changes

9.3.3 CHANGE THE TYPE OF MDECU: (ACTUATOR DRIVE ONLY)

- Press ENTER to advance to the GENERAL CONFIG screen
- Press LINE 2 twice to highlight MDECU MODE
- Press ENTER to change MDECU MODE. *An asterisk (*) will be displayed*
- Press INC or DEC buttons to select
- Select ACTUATOR MDECU if the black box located on the air seeder between the 2 rear bins; has UNIVERSAL MULTI DRIVE ECU stamped on the box

OR • Select ACTUATOR SATCOM if the black box located on the air seeder between the 2 rear bins; has SATELLITE COMMANDER stamped on the box

- Press ENTER to accept changes

9.3.4 CHECK MDECU VERSION NUMBER

- If the Simplicity Console, tractor harness, implement with any extension harness, chassis harness and the Multi Drive Electronic Drive Unit (MDECU) are correctly installed, then a version number will be displayed in this window.

Note: There are two version numbers displayed, if the MDECU connected to the Simplicity console has only '2' Drives then the top number displayed will be version number of the MDECU and the second version number will display '0.0'.

*If the MDECU connected to the Simplicity console has '4' Drives then the top number displayed will be version number of the first processor in the MDECU and the second version number will be displayed represents the second processor. These version numbers **MUST BE THE SAME**. Contact your Simplicity dealer if the version numbers are different on a '4' Drive MDECU*

- This number represents the version of firmware installed on the MDECU.
- This number maybe needed by a KEE Service Representative.
- *Note: For earlier air seeders that have SATELLITE COMMANDER stamped on the box, the Version number displayed in the window will be 0.0.*

9.3.5 TOGGLE DISPLAY POLLING

- Press ENTER to advance to the GENERAL CONFIG screen
- Press LINE 3 twice to highlight DISPLAY POLLING
- Press ENTER to edit DISPLAY POLLING. *An asterisk (*) will be displayed*
- Press INC or DEC buttons to switch between ON and OFF
**OFF MUST BE SELECTED FOR ALL OPERATIONS.
MUST ONLY BE SWITCHED ON WHEN DIRECTED BY A KEE SERVICE
REPRESENTATIVE**
- Press ENTER to accept changes

9.3.6 DIAGNOSTICS MODE

- Press ENTER to advance to the GENERAL CONFIG screen
- Press LINE 3 to highlight DIAGNOSTICS MODE
- Press ENTER to advance to the DIAGNOSTICS MODE screen
Go to Section 10.0 for further details.

9.3.7 RESTORE TO FACTORY SETTINGS

- Press ENTER to advance to the GENERAL CONFIG screen
- Press LINE 4 to highlight COLD RESET (RESTORE DEFAULTS)
- Press ENTER to advance to COLD RESET screen
- Press MENU to go back to the GENERAL CONFIGURATION SCREEN

OR

- Press the RESET button on the console. *This will restore ALL settings and values in the Eagle Console back to the original settings set in the factory.*
- *Once the RESET button has been pressed, the console will revert back to the original factory settings and the Console will automatically AUTO POWER DOWN.*
- *The Console will then automatically POWER ON and start up at the Working Screen.*

10.0 DIAGNOSTICS MODE

- Hold the RESET button down (for approximately 5 seconds) while switching the POWER switch ON.
- Press ENTER to advance to the GENERAL CONFIG screen
- Press LINE 3 to highlight DIAGNOSTICS MODE
- Press ENTER to advance to the DIAGNOSTICS MODE screen
- Press LINE 1, 2, 3 or 4 to move around the screen, till the TEST that is required, is highlighted
- Press ENTER to advance the selected test screen
- Press DEC to exit from any of the test screens



Diagnostics Screen

10.1 LED TEST

- Select this to check the operation of the Light Emitting Device (LED)'s on the front panel. Diagram below shows the positions of the LED's
- If operating correctly the LED's will cycle consecutively around the front panel, starting from the:
 - 1)- Right hand side of console from top to bottom,
 - 2)- Bottom side of console from left to right
- then once one cycle has been completed, all the LED's will flash together.
- Press the DEC button to exit

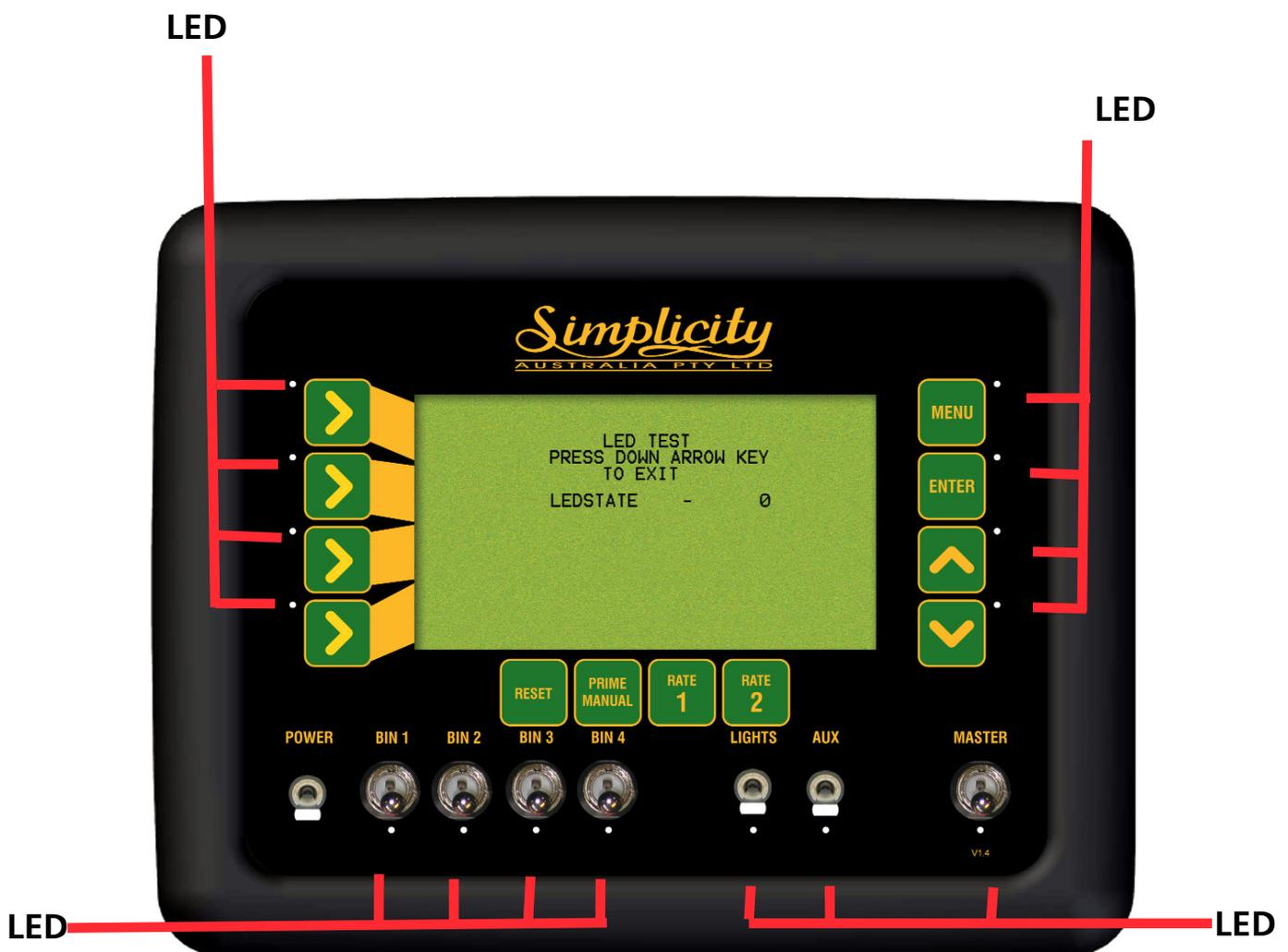

LED Test Screen

10.2 SWITCH TEST

- Select this to check the operation of the switches
- If operating correctly:
 - The MASTER switch when in the OFF position;
 - “MASTER SWITCH = OFF will be displayed on the console screen
 - The MASTER switch when in the ON position;
 - “MASTER SWITCH = ON will be displayed on the console screen
- Status of the Bin switches (1 to 4) will be indicated by SW 1 to SW 4 on the test screen.

When the position of the Bin switch is in the DOWN position the corresponding SW indicator will point DOWN. When the Bin switch is in the UP position the corresponding SW indicator arrow will point UP

- Status of the LIGHTS switch will be indicated by SW 6
- Status of the AUX switch will be indicated by SW 7
- Press the DEC button to exit



Switch Test Screen

10.3 KEYS TEST

- Select this to check the operation of the buttons on the front panel
- If operating correctly by pressing any button, the button that is pressed will be displayed on the screen
- Press the DEC button to exit



Keys Test Screen

10.4 SENSORS TEST

- Select this test to check the operation of the sensor circuitry
- The current period (time between pulse, measured in mS) for each sensor will be displayed on the screen.
- During operation the period between the pulses should be constant, if this figure is not constant then this suggests there is a magnet missing or a sensor distance is not set properly.
- The pulse count keeps accumulating as each magnet goes past the sensor.
- Press the DEC button to exit



Sensor Test Screen

10.4.1 CHECKING HARNESS VOLTAGES, FOR 3 PIN SENSORS

- This test should be carried out if the sensor (ground speed sensor, metering shaft sensors, fan shaft sensor) that appears to be faulty has been checked using the Diagnostic Test in Section 10.4., and no 'pulse count', or no 'period' can be observed or the period is erratic.
- This test will check the sensor is receiving the correct voltages, from the chassis harness.
- To carry out this test a multimeter is required which can measure DC voltage between 1 and 24 volts. A ruler to measure distance between sensor and magnet.
- This test procedure can be carried out on ground speed sensors, metering shaft sensors and the fan speed sensor all which have a 3 pin weather-pak connector, which connects the sensor to the chassis harness. Each connector has A, B and C marked on the connector. If the A,B and C are covered by shrink-wrap, then use diagram below to determine A,B and C pins position
- Check the the distance between the magnet and sensor. The distance should be 2 to3 millimeters. Rectify if distance is incorrect.
- If checking ground speed sensor check to make sure no magnets are missing and that they are evenly spaced apart.
- Check for obvious signs of damage (breakage, corrosion etc) to the sensor, plug and wiring. Rectify any damage.

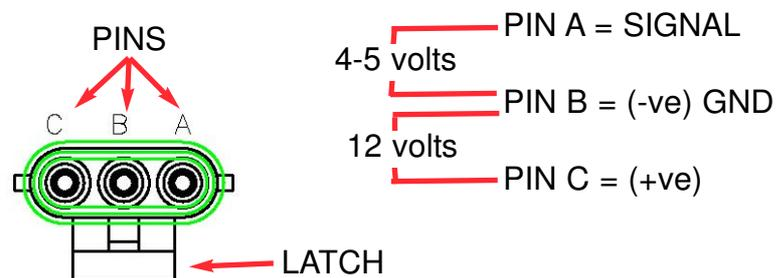

'HARNESS' 3PIN Weather-Pak Plug

- From the sensor trace back the wiring to the 3 pin weather-pak plug, unplug the sensor plug from the chassis harness plug.
- Switch Console POWER switch ON.
- The 'Latch' on the plug is what holds the 2 plugs together. With the 'Latch' facing down (as shown in diagram), the Pins starting from the left are: C, B and A.
- Using multi-meter, the voltage between PIN C and PIN B should be 12 volts.
- Using multi-meter, the voltage between PIN A and PIN B should be 4-5 volts.
- If the voltages are correct as above then this would suggest a faulty sensor.
- If one or both voltages are incorrect then write down the actual voltages and contact your local Simplicity Dealer.

10.4.2 PRESSURE SENSOR TEST

This is a simple test procedure that determines whether the pressure transducer sensor is functioning properly. A multi-meter is required which can measure DC voltage between 1 and 24 volts.

- The pressure transducer sensor is mounted on the air seeder chassis near the fan.
- The sensor has 2 weather-pak plugs (one with a red collar and one with a blue collar) and a spigot with a rubber hose which goes to the fan.
See diagram of Pressure Transducer Sensor at bottom of page, showing red collar plug, blue collar plug and air hose
- For correct operations the weather-pak plug with the **red collar** should be connected to the chassis harness; if the red collar plug is not connected, then do so now and check the console for a pressure reading; the blue collar plug is used for testing.
- To test the sensor unplug red collar plug from chassis harness.
- Connect the blue collar plug to the chassis harness.

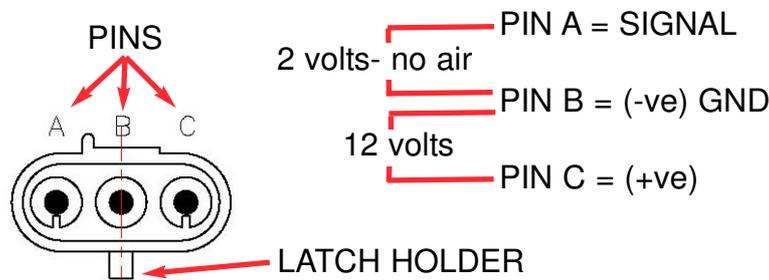

Red collar 3PIN Weather-Pak Plug

- Switch Console POWER switch ON.
- The 'Latch Holder' on the plug is what holds the 2 plugs together. With the 'Latch Holder' facing down (as shown in diagram), the Pins starting from the left are: A, B and C.
- Using a multi-meter, the voltage between PIN C and PIN B should be 12 volts.
- Using multi-meter, the voltage between PIN A and PIN B should be 2 volts.
- Unplug the rubber hose from where it is attached to the fan.
- With the multi meter still across PIN A and PIN B, blow hard into the hose, the voltage should read approximately 3 volts.
- Once testing is finished ensure the weather-pak plug with the 'Red Collar' is connected to the chassis harness and then connect the rubber hose back to the spigot on the fan.
- If one or both voltages are incorrect then write down the actual voltages and contact your KEE Dealer.

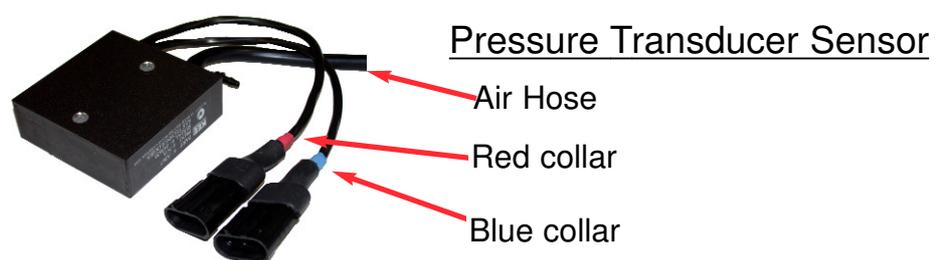

10.5 RELAY TEST

- Select this to check the operation of all the relay circuitry
- This test, cycles through each relay within the console; and each of the three states of each relay
- If operating correctly and a "Light" and or a "Wing Cut-off" kit is installed using the LIGHTS and AUX plugs on the harness then during the RELAY TEST regardless of the position of the Console switches
 - 1) Any LIGHT KIT connected to the LIGHTS plug will switch ON then OFF
 - 2) Any AUX kit (Wing Cut-off or another LIGHT kit) connected to the AUX plug of the harness will switch ON then OFF.
- This test isolates whether it is a relay problem in the console or an actual switch problem in the console
- Press the DEC button to exit



Relay Test Screen

10.6 BIN LEVELS TEST

- Select this to check the operation of the bin level sensors
- If operating correctly, when the product fully covers the bin sensor the particular bin should say FULL.
- If the product does not fully cover the bin level sensor the particular bin will say EMPTY.
- Press the DEC button to exit



Bin Levels Test Screen

10.6.1 BIN LEVEL SENSOR ADJUSTMENT

The Bin Level Sensors should be adjusted when fitted to a system and at the start of each season, They are sensitive to voltage changes and may operate differently on a different tractor. They are also sensitive to different products, and while they will work with grain such as wheat, re-adjustment may be required to detect Urea. Once set to work with Urea, they will work on all other products provided voltage supplies remain the same.

- The unit should be mounted so that there is nothing within 2 inches of the front of the sensor, bin struts, side walls, product etc.
- Turn the Eagle console ON, with sensor in free space or in an empty bin
- Check the sensor light. If OFF, turn the adjusting screw counterclockwise until the light comes on.
- If the light is on, turn the screw clockwise until it goes off then turn back again until it just comes on.
- Place a hand near the sensor cap, or place the sensor in the product that will be in the bin. The light should go off.
- Remove the product or hand, the light should come on when the cap has a clearance of 1.5 to 2 cms from the product or hand. If using a hand to set the sensor, check the operation with the product as this is only a rough guide to simplify testing.
- Adjust the screw if necessary to achieve this result.
- Repeat the procedure for each Bin
- If set with Urea, the sensor light should go off when the end is in the product approximately 1 cm, with wheat etc, the light should go off just as the sensor face touches the product, and come back on again at approximately 2 cm clearance.

10.6.2 CHECKING HARNESS VOLTAGES, FOR BIN SENSOR

- This test should be carried out if the bin level sensor appears to be faulty has been checked using the Diagnostic Test in Section 10.6. This test will check the sensor is receiving the correct voltages.
- To carry out this test a multimeter is required which can measure DC voltage between 1 and 24 volts.
- Each bin level sensor has a 2 pin weather-pak connector and has A and B marked on the connector.
- Check for obvious signs of damage (breakage, corrosion etc) to the sensor, plug and wiring. Rectify any damage.
- From the sensor trace back the wiring to the 2 pin weather-pak plug, unplug the sensor plug from the chassis harness plug.
- Switch Console POWER switch ON.

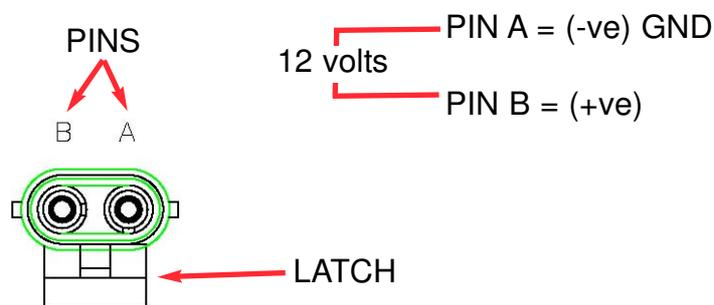

'HARNESS' 2 PIN Weather-Pak Plug

- The 'Latch' on the plug is what holds the 2 plugs together. With the 'Latch' facing down (as shown in diagram), the Pins starting from the left are: B and A.
- Using a multi-meter, the voltage between PIN A and PIN B on the chassis harness should be 12 volts.
- If the voltage is incorrect then write down the actual voltage and contact your KEE Dealer.

10.6.3 CHECKING HARNESS VOLTAGES, CLUTCH

This checks the plug marked 'CLUTCH' on the Tank Harness see Section 14.4. The CLUTCH plug is a white '2 pin' plug. The CLUTCH is the main clutch which disengages or engages the air seeder; the CLUTCH is switched ON or OFF using the MASTER switch on the console.

- A Multi-Meter which reads DC volts in the 20Volt range is required.
- Switch the Console POWER switch ON
- Unplug the connector from the air seeder clutch, from the plug on the Tank Harness.
- Connect the multimeter across the Tank Harness, CLUTCH connector.
 - 1- With the Master Switch OFF; 0Volts should be read.
 - 2- With the Master Switch ON; (12 to13.8) Volts should be read.

10.7 MEMORY TEST

- Select this to check the operation of the read/write to memory chip.
- When on the memory test page, the lines should keep scrolling. If it stops on a particular line, there is a problem, and the information is not being saved properly to the chip.
- Press DEC button to exit



Memory Test Screen

10.8 DISPLAY TEST

- Select this to check the operation of the pixels on the display screen
- When on the Display Test page the screen will start blackening from the left to right. This test will show whether all pixels are working on the screen.
- Press the DEC button to exit.

11.0 ALARM MESSAGES

11.1 Alarm Messages Overview

All alarms to alert the operator will flash in the 'Alarm Window'. The frequency and whether an alarm sounds when an alarm is displayed in the 'Alarm Window' is set in the ALARM CONFIGURATION see Section 9.2. The alarm will keep flashing in the 'Alarm Window' till the problem is rectified. If there is more than one alarm present then the alarms will scroll through in the 'Alarm Window' one alarm at a time, the first alarm will flash a number of times, then the next alarm will flash and so forth, until all alarms have been displayed. The 'Alarm Window' will then start again with the first alarm. A list of all the alarms and an explanation for each alarm are listed on the following pages.



Working Screen

11.2 Fan Alarms

- **Fan Pressure Low-** if the fan pressure goes below the programmed Alarm Point, the message “FAN PRESS LOW” flashes in the ‘Alarm Window’ and the alarm sounds.
- **Fan Pressure High-** if the fan pressure goes above the programmed Alarm Point, the message “FAN PRESS HIGH” flashes in the ‘Alarm Window’ and the alarm sounds.
- **Fan Speed Low-** if the fan speed goes below the programmed Alarm Point, the message “FAN SPEED LOW” flashes in the ‘Alarm Window’ and the alarm sounds.
- **Fan Speed High-** if the fan speed goes above the programmed Alarm Point, the message “FAN PRESS HIGH” flashes in the ‘Alarm Window’ and the alarm sounds.

11.3 Metering Shaft Alarms

- **Shaft 1 Stopped-** if bin metering Shaft 1 stops rotating, the message “SHAFT 1 STOPPED” flashes in the ‘Alarm Window’ and the alarm sounds.
- **Shaft 2 Stopped-** if bin metering Shaft 2 stops rotating, the message “SHAFT 2 STOPPED” flashes in the ‘Alarm Window’ and the alarm sounds.
- **Shaft 3 Stopped-** if bin metering Shaft 3 stops rotating, the message “SHAFT 3 STOPPED” flashes in the ‘Alarm Window’ and the alarm sounds.
- **Shaft 4 Stopped-** if bin metering Shaft 4 stops rotating, the message “SHAFT 4 STOPPED” flashes in the ‘Alarm Window’ and the alarm sounds.

11.4 Rate Alarms

- **Rate 1 Alarm-** if the selected application rate for BIN 1, can not be controlled to within 5% (above or below the rate), the message “RATE 1 ALARM” flashes in the ‘Alarm Window’, the alarm sounds. and the “actual” rate being metered will be displayed on LINE 1.
- **Rate 2 Alarm-** if the selected application rate for BIN 2, can not be controlled to within 5% (above or below the rate), the message “RATE 2 ALARM” flashes in the ‘Alarm Window’, the alarm sounds. and the “actual” rate being metered will be displayed on LINE 2.
- **Rate 3 Alarm-** if the selected application rate for BIN 3, can not be controlled to within 5% (above or below the rate), the message “RATE 3 ALARM” flashes in the ‘Alarm Window’, the alarm sounds. and the “actual” rate being metered will be displayed on LINE 3.
- **Rate 4 Alarm-** if the selected application rate for BIN 4, can not be controlled to within 5% (above or below the rate), the message “RATE 4 ALARM” flashes in the ‘Alarm Window’, the alarm sounds. and the “actual” rate being metered will be displayed on LINE 4.

11.5 Bin Low (Sensor) Alarms

- **Bin 1 Low Alarm-** when the product level in BIN 1 falls below the sensor, the message “BIN 1 LOW” flashes in the ‘Alarm Window’ and the alarm sounds.
- **Bin 2 Low Alarm-** when the product level in BIN 2 falls below the sensor, the message “BIN 2 LOW” flashes in the ‘Alarm Window’ and the alarm sounds.
- **Bin 3 Low Alarm-** when the product level in BIN 3 falls below the sensor, the message “BIN 3 LOW” flashes in the ‘Alarm Window’ and the alarm sounds.
- **Bin 4 Low Alarm-** when the product level in BIN 4 falls below the sensor, the message “BIN 4 LOW” flashes in the ‘Alarm Window’ and the alarm sounds.

11.6 Bin Empty (Contents) Alarms

- **Bin 1 Empty Alarm-** will alarm when the air seeder has calculated the last of the product has been metered, through BIN 1, “BIN 1 EMPTY” flashes in the ‘Alarm Window’ and the alarm sounds.
- **Bin 2 Empty Alarm-** will alarm when the air seeder has calculated the last of the product has been metered, through BIN 2, “BIN 2 EMPTY” flashes in the ‘Alarm Window’ and the alarm sounds.
- **Bin 3 Empty Alarm-** will alarm when the air seeder has calculated the last of the product has been metered, through BIN 3, “BIN 3 EMPTY” flashes in the ‘Alarm Window’ and the alarm sounds.
- **Bin 4 Empty Alarm-** will alarm when the air seeder has calculated the last of the product has been metered, through BIN 4, “BIN 4 EMPTY” flashes in the ‘Alarm Window’ and the alarm sounds.

11.7 Blocked Head Alarms

- **BLOCKED HEAD-** when the MASTER switch is in the ON position, and the BLOCKED HEAD alarm appears in the ‘Alarm Window’ and the alarm sounds; this indicates one of the sensors is ‘blocked’ or no product is flowing pass the sensor.
Switch the MASTER switch OFF, this will ‘latch’ onto the offending sensor. Inspect the sensor (the red LED on the sensor will be illuminated), fix the problem.
Switching the MASTER ON will reset the Blocked Head Sensors.

11.8 Other Alarms

- **No Ground Speed-** when no signal is detected from the wheel sensor on the air seeder or tractor radar (if fitted), when a Bin is switched ON and MASTER is in the ON position. This will occur any time the air seeder stops and is intended as a warning only.
If the “NO GROUND SPEED” message flashes in the ‘Alarm Window’ and the alarm sounds and the air seeder is moving, the wheel sensor (on air seeder) or Tractor radar (if fitted), should be checked immediately.
- **NO COMMs-** if the Multi Drive Electronic Control Unit (MDECU) is disconnected, from the Console, the message flashes in the ‘Alarm Window’ and the alarm sounds. No seeding is possible if this alarm is present.
- **MASTER OFF-** when a Bin is switched ON and the MASTER switch is in the OFF position, after a set period, the message “MASTER OFF” flashes in the ‘Alarm Window’ and the alarm sounds.
This alarm is intended as a warning only.
- **HIGH TEMP-** when the MDECU box, reaches or exceeds the maximum temperature, the message “HIGH TEMP” flashes in the ‘Alarm Window’ and the alarm sounds.
- **TANKS OFF -** when the MASTER is switched to the ON position; but the Bin switches are switched OFF, the TANKS OFF will flash in the ‘Alarm Window’ This alarm is intended as a warning only.
- **TURN MASTER OFF-** when the MASTER switch is in the ON position and the operator tries to PRESS a button that requires the MASTER switch to be in the OFF position (ie go to the sub menu's) then the TURN MASTER OFF alarm flashes in the ‘Alarm Window.’

11.9 Liquid Alarms (Liquid Only)

- **Liquid Pressure Low-** if the Liquid pressure goes below the programmed Alarm Point, the message “LIQUID PRESSURE LOW” flashes in the ‘Alarm Window’ and the alarm sounds.
- **Liquid Pressure High-** if the Liquid pressure goes above the programmed Alarm Point, the message “LIQUID PRESSURE HIGH” flashes in the ‘Alarm Window’ and the alarm sounds.
- **Pump Speed Low-** if the Pump speed goes below the programmed Alarm Point, the message “PUMP SPEED LOW” flashes in the ‘Alarm Window’ and the alarm sounds.
- **Pump Speed High-** if the Pump speed goes above the programmed Alarm Point, the message “PUMP SPEED HIGH” flashes in the ‘Alarm Window’ and the alarm sounds.
- **LOW SPEED SHUTOFF-** with MASTER switch ON, BIN switches ON and SPEED displayed. When the speed of the air seeder falls below the value set in the LOW SPEED SHUTOFF (See Section 8.3.11), the message “LOW SPEED flashes in the ‘Alarm Window’ and the alarm sounds.
- **MINIMUM FLOW-** with MASTER switch ON, BIN switches ON and SPEED displayed. Then when the FLOW RATE (litres/minute) falls below the value set in the MINIMUM FLOW (See Section 8.3.12) the message “MIN FLOW LOW” flashes in the ‘Alarm Window’ and the alarm sounds.

12.0 SPECIFICATIONS

12.1 Console

- **Supply Voltage** 13 - 16 volts Negative earth system.

The Console's power leads must be connected directly to the tractors battery terminals.

No attempt should be made to connect the system to positive earth vehicle. Damage will result and Warranty will become void.

- **Supply Current Console** 0.9 amps approxlmatly.
- **LIGHTS and AUX switches** **Maximum 50 Watts continuous for each switch**
12 VDC across the LIGHTS and AUX connectors on the Tank Harness when switched ON at the console.

12.2 Ground Speed, Fan Speed, Metering Shaft Sensors

Ground Speed Sensor, Fan Speed Sensor and Shaft Sensors: Hall effect type sensors
3 pin weather-pak plug (Pin A, B and C)

Sensor to Magnet Distance 2-3 millimeters (mm)

Supply Voltage Supply 12 volts from MDECU

Signal Voltage: 4 -5- volts sensor inactive
< 1 volt sensor activated by magnet

12.3 Fan Pressure Sensors

Fan Pressure Sensor: Solid state aircraft altimeter type. Max. error 1%
Connect 'Red Collar' plug to Tank Harness.

12.4 Bin Level Sensors

Bin Level Sensor: Solid state capacitive type.
2 Pin weather-pak plug (Pin A and B)
Triggered on flat end
Sensitivity adjustable for light material eg. Urea

Supply Voltage Supply 12 volts from MDECU

13.0 SYSTEM COMPONENTS

For a Typical 2 Bin Air Seeder

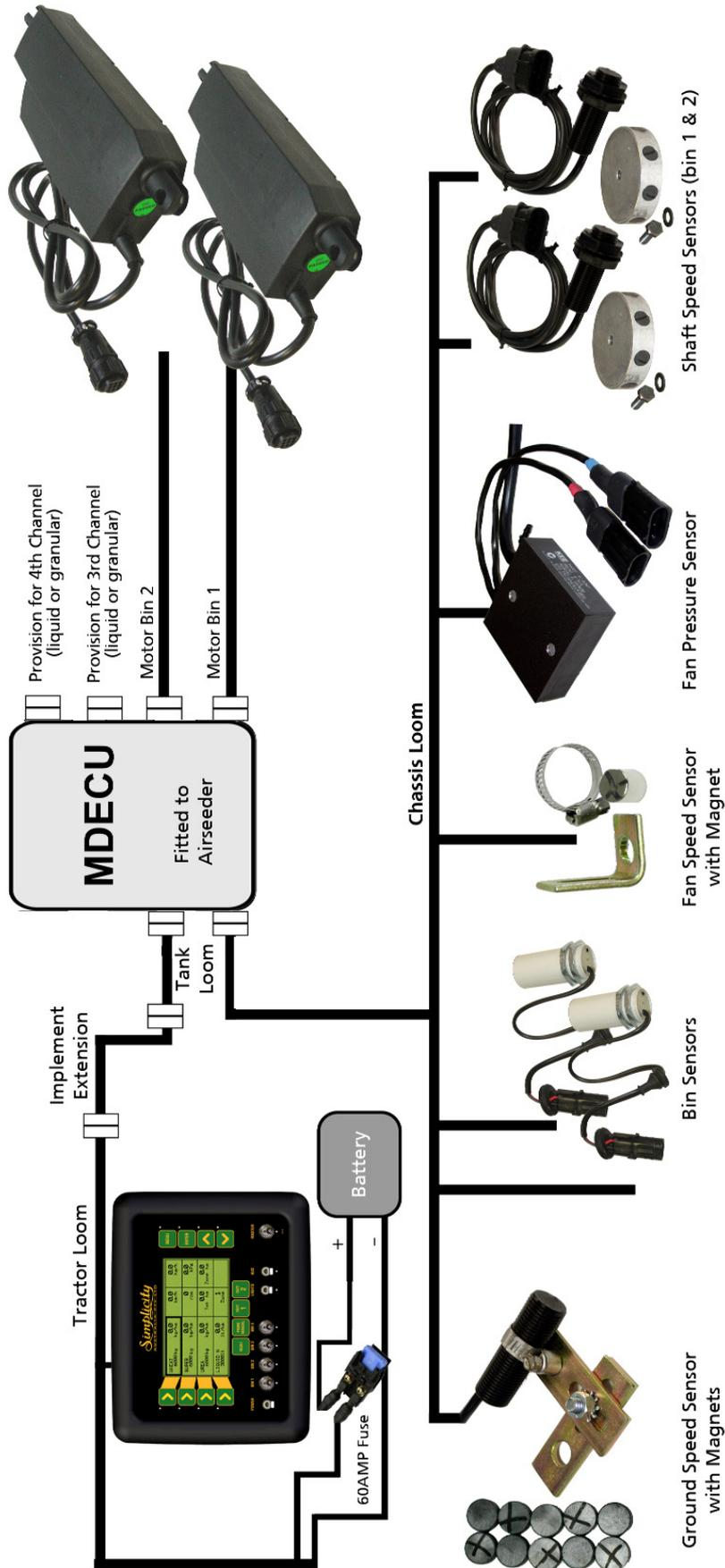

13.1 SYSTEM COMPONENTS- PARTS LIST

For a Typical 2 Bin Simplicity Air Seeder Controller

<u>Item</u>	<u>Part Number</u>	<u>QTY</u>
• Simplicity Seedrate Control Console-	A1755	1
• Harnesss		
Tractor Harness	A1973	1
Implement Extension Harness(12.5m)	A467	1
Chassis Extension Harness	A468	1
Tank Harness	A453	1
• Motor Drive Electronic Control Unit (MDECU)		
2 Channel MDECU	A1525	1
or 4 Channel MDECU	A1526	1
• Ground Speed Sensor	A1200	1
"L" Angle Speed Sensor Bracket	A006	1
or Slotted Speed Sensor Bracket	A007	1
10 Magnet Wheel Kit	A369	1
• Fan Speed Sensor	A1200	1
Fan Magnet	A368	1
• Bin Level Sensor		
Bin Level Sensor only	A667	2
or Bin Level Sensor with Bracket	A1201	2
• Fan Pressure Sensor Kit	A267	1
• Shaft Speed Sensor	A1200	2
"L" Angle Speed Sensor Bracket	A006	2
or Slotted Speed Sensor Bracket	A007	2
Block Magnet and Clamp	A402	2
• Remote Master Switch (Optional)	A601	1
• Spares		
16 Pin Locking Ring Kit (pack of 3)	A1478	
Fuse 10 Amp 3AG (Console fuse)	Y846	
Fuse 20 Amp (LIGHTS and AUX fuse)	Y848	

• **Liquid Upgrade kit (Optional)**

Note: Contact your Simplicity dealer for Liquid Upgrade options for your Simplicity air seeder system

13.1. SYSTEM COMPONENTS- PARTS LIST

For a Typical 2 Bin Simplicity Air Seeder Controller

<u>Item</u>	<u>Part Number</u>	<u>QTY</u>
• GPS Speed Kit (Optional)		
5Hz GPS Receiver	A3023	1
OR 1Hz GPS Receiver	A1677	1
DB9 Null Modem Cable	A1507	1
Power Adaptor Harness	A3017	1
• Eagle Seeder to X20 XLink(Optional)		
	A2953	1
<i>Note: Requires an X10, X15 or X20 Console</i>		
• Simplicity Monitor Blocked Head Sensor kit		
	A3105	1
<i>The A3105 kit Includes 5 x A022 Blocked Sensors</i>		
Blocked Head Adaptor Harness	A2667	1
3 Wire Adaptor extension harness 5m (16ft)	A768	1
3 Wire Adaptor extension harness 9m (29.5ft)	A2018	1
extra sensors if required Sensor 32mm	A022	1
<i>Note: up to 18 Sensors can be connected to a Simplicity Console</i>		

14.0 WIRING DIAGRAMS

14.1 CONSOLE PINOUTS

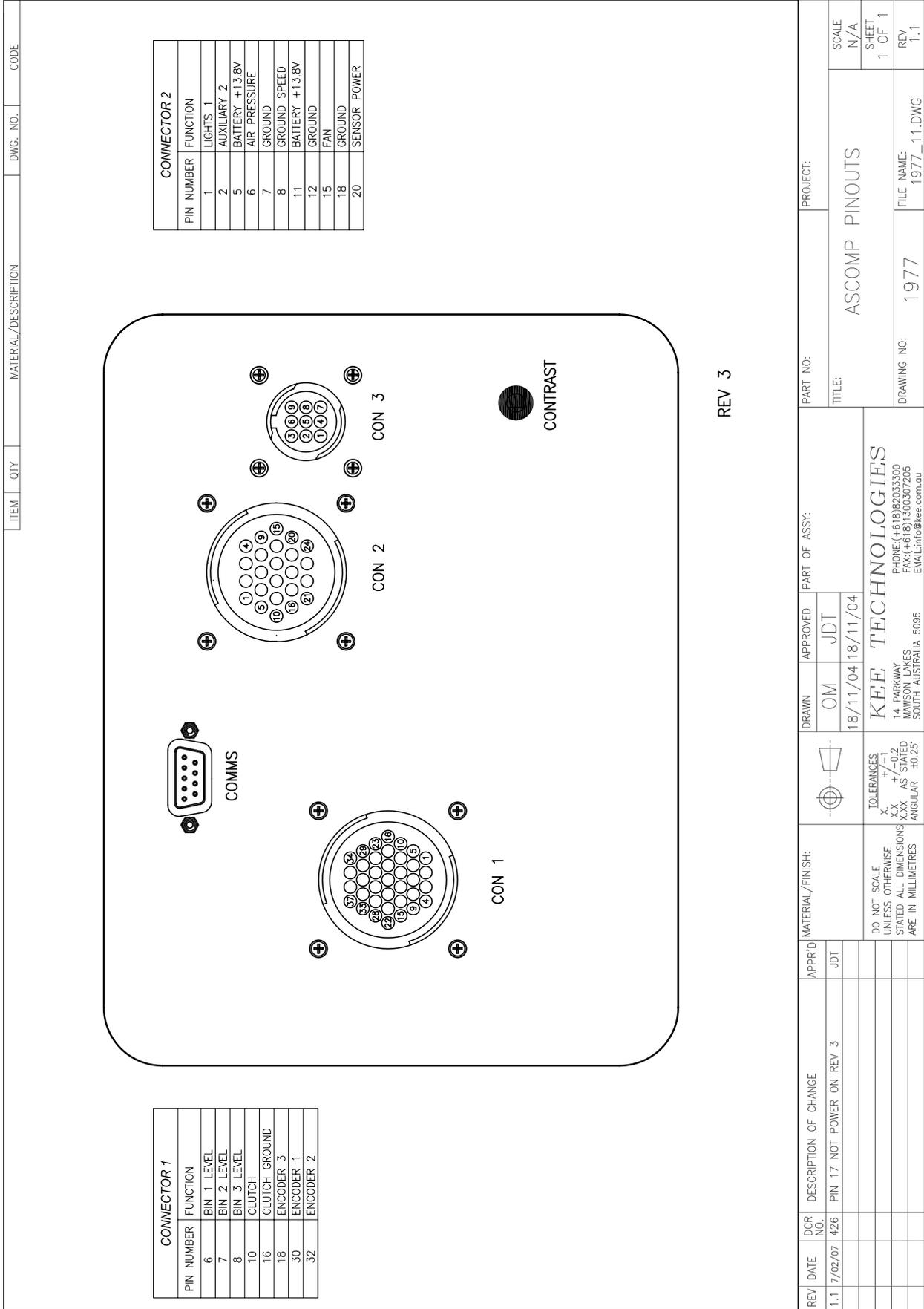

COPYRIGHT: THIS DRAWING IS THE PROPERTY OF KEE TECHNOLOGIES. IT MAY NOT BE REPRODUCED IN WHOLE OR IN PART WITHOUT THEIR WRITTEN PERMISSION.

14.2 TRACTOR HARNESS

COPYRIGHT: THIS DRAWING IS THE PROPERTY OF KEE TECHNOLOGIES. IT MAY NOT BE REPRODUCED IN WHOLE OR IN PART WITHOUT THEIR WRITTEN PERMISSION.

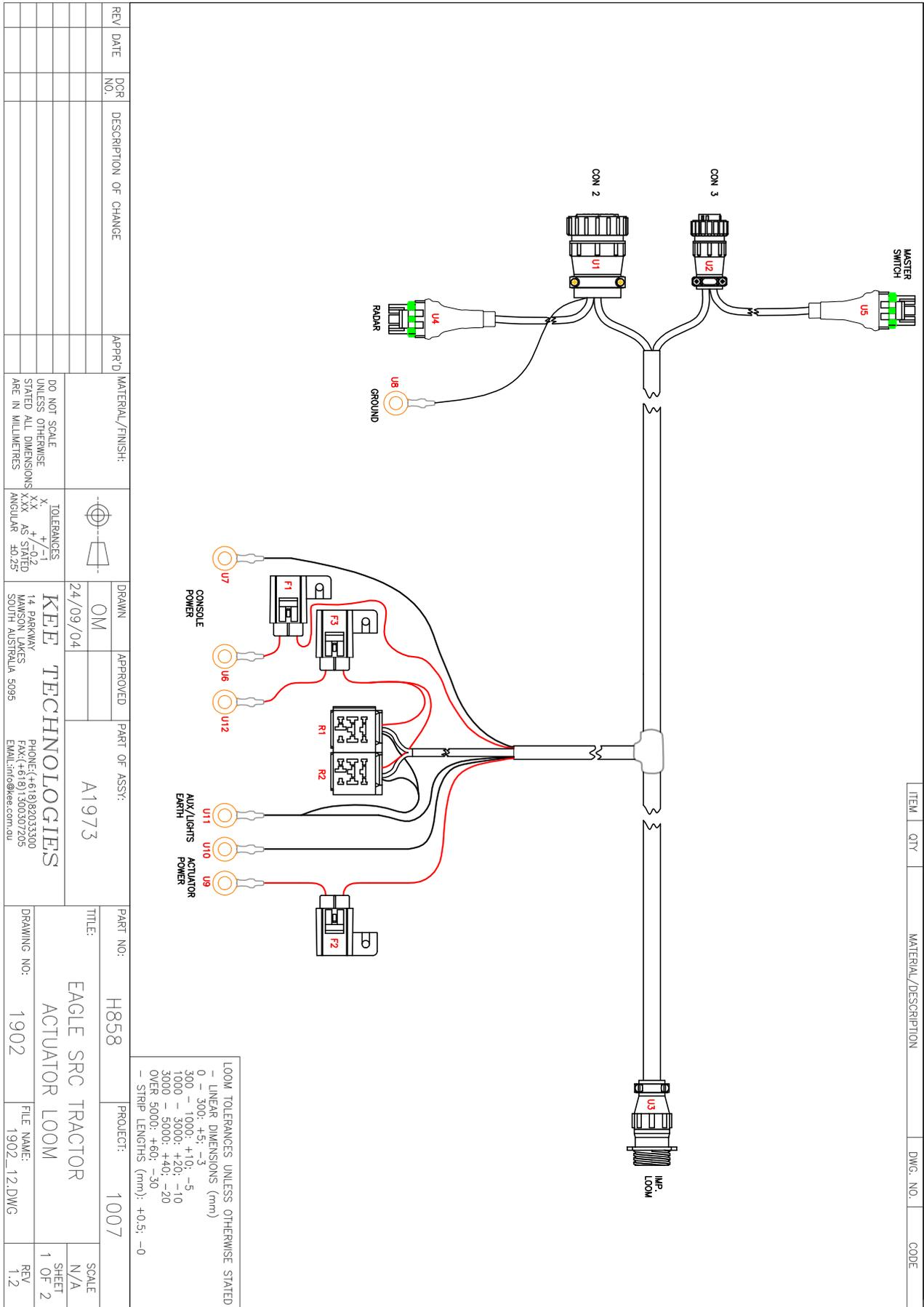

REV	DATE	DCR NO.	DESCRIPTION OF CHANGE	APPR'D	MATERIAL/FINISH:	TOLERANCES	DRAWN	APPROVED	PART OF ASSY:	PART NO:	PROJECT:	SCALE
						DO NOT SCALE UNLESS OTHERWISE STATED ALL DIMENSIONS ARE IN MILLIMETRES	X XX XXX ANGULAR	+/0.2 AS STATED ±0.25°	24/09/04 OM	A1973	H858	N/A
							KEE TECHNOLOGIES 14 PARKWAY MAMSON LAKES SOUTH AUSTRALIA 5095		PHONE: (+618)82033300 FAX: (+618)1300507295 EMAIL: info@kee.com.au	EAGLE SRC TRACTOR ACTUATOR LOOM	1007	SHEET 1 OF 2
									DRAWING NO: 1902	FILE NAME: 1902_12.DWG		REV 1.2

LOOM TOLERANCES UNLESS OTHERWISE STATED
 - LINEAR DIMENSIONS (mm)
 0 - 300: +5; -3
 300 - 1000: +10; -5
 1000 - 3000: +20; -10
 3000 - 5000: +40; -20
 OVER 5000: +60; -30
 - STRIP LENGTHS (mm): +0.5; -0

ITEM	QTY	MATERIAL/DESCRIPTION	DWG. NO.	CODE

14.3 IMPLEMENT EXTENSION

COPYRIGHT: THIS DRAWING IS THE PROPERTY OF KEE TECHNOLOGIES. IT MAY NOT BE REPRODUCED IN WHOLE OR IN PART WITHOUT THEIR WRITTEN PERMISSION.

REV	DATE	DCR NO.	DESCRIPTION OF CHANGE	APPR'D	MATERIAL/FINISH:	TOLERANCES X XX XXX AS STATED ANGULAR	DRAWN	APPROVED	PART OF ASSY:	PART NO:	PROJECT:	SCALE
						 DO NOT SCALE UNLESS OTHERWISE STATED ALL DIMENSIONS ARE IN MILLIMETRES	OM		A467	H521		N/A
						X XX XXX AS STATED ANGULAR +/0.25°	KEE TECHNOLOGIES 14 PARKWAY MAWSON LAKES SOUTH AUSTRALIA 5095		PHONE: (+618) 82033300 FAX: (+618) 1300307205 EMAIL: info@kee.com.au			1 OF 2
												1 OF 2
												C

TO TRACTOR
LOOM

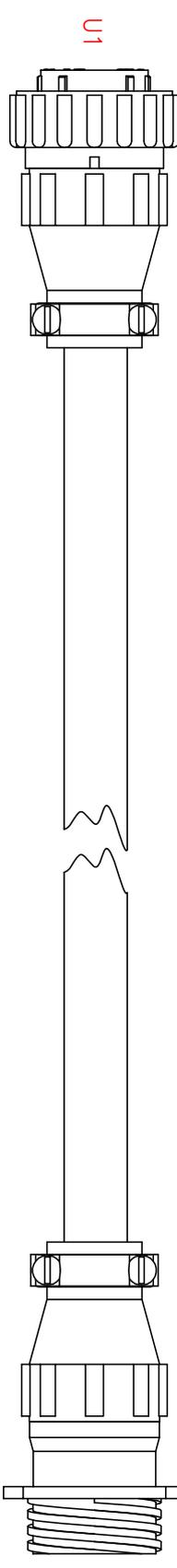

TO TANK
EXT. LOOM

LOOM TOLERANCES UNLESS OTHERWISE STATED

- LINEAR DIMENSIONS (mm)

0 - 300: +5; -3

300 - 1000: +10; -5

1000 - 3000: +20; -10

3000 - 5000: +40; -20

OVER 5000: +60; -30

- STRIP LENGTHS (mm): +0.5; -0

ITEM	QTY	MATERIAL/DESCRIPTION	DWG. NO.	CODE

14.4 TANK EXTENSION HARNESS

COPYRIGHT: THIS DRAWING IS THE PROPERTY OF KEE TECHNOLOGIES. IT MAY NOT BE REPRODUCED IN WHOLE OR IN PART WITHOUT THEIR WRITTEN PERMISSION.

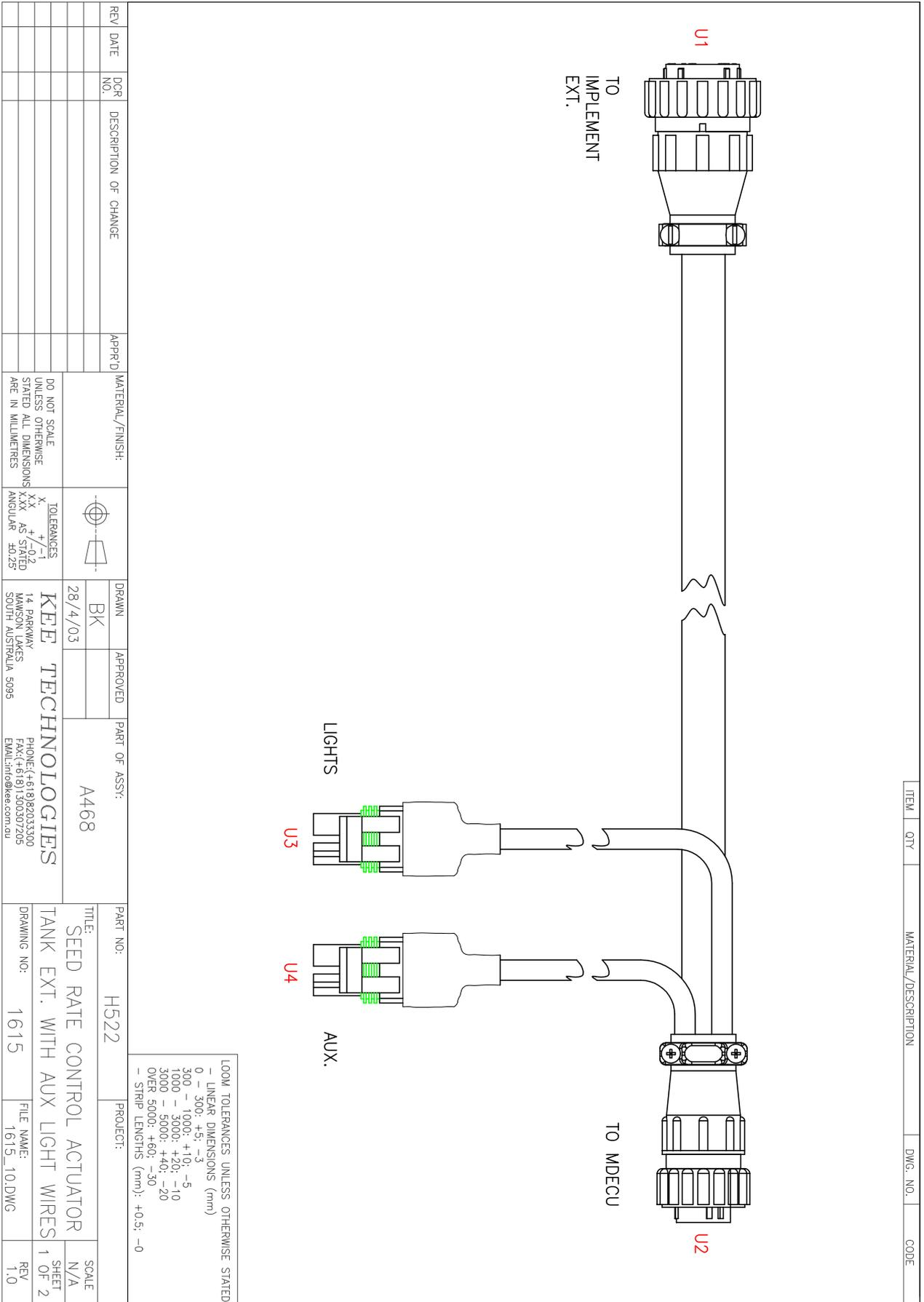

14.5 TANK HARNESS

COPYRIGHT: THIS DRAWING IS THE PROPERTY OF KEE TECHNOLOGIES. IT MAY NOT BE REPRODUCED IN WHOLE OR IN PART WITHOUT THEIR WRITTEN PERMISSION.

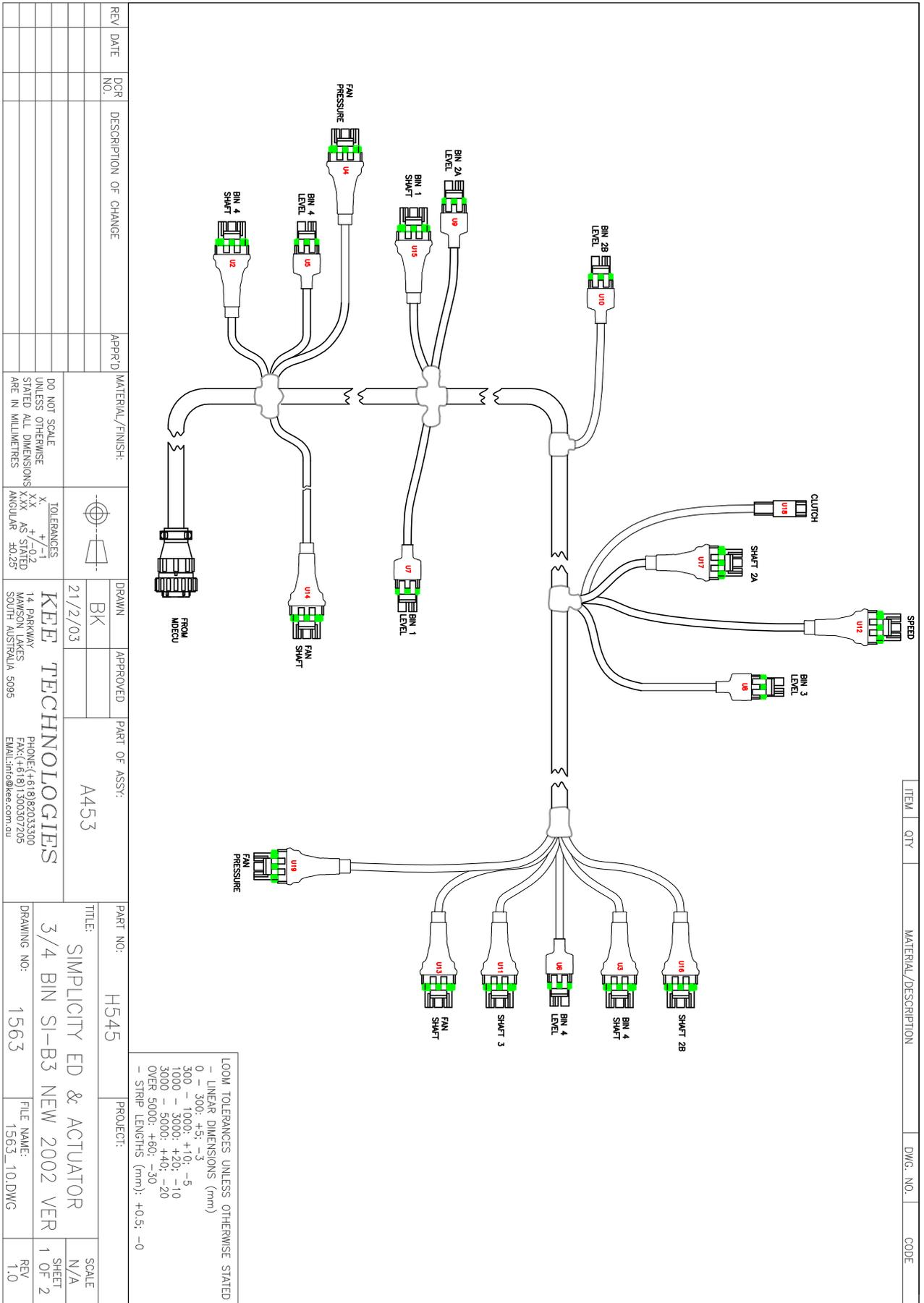

14.6 LIQUID HARNESS LAYOUT

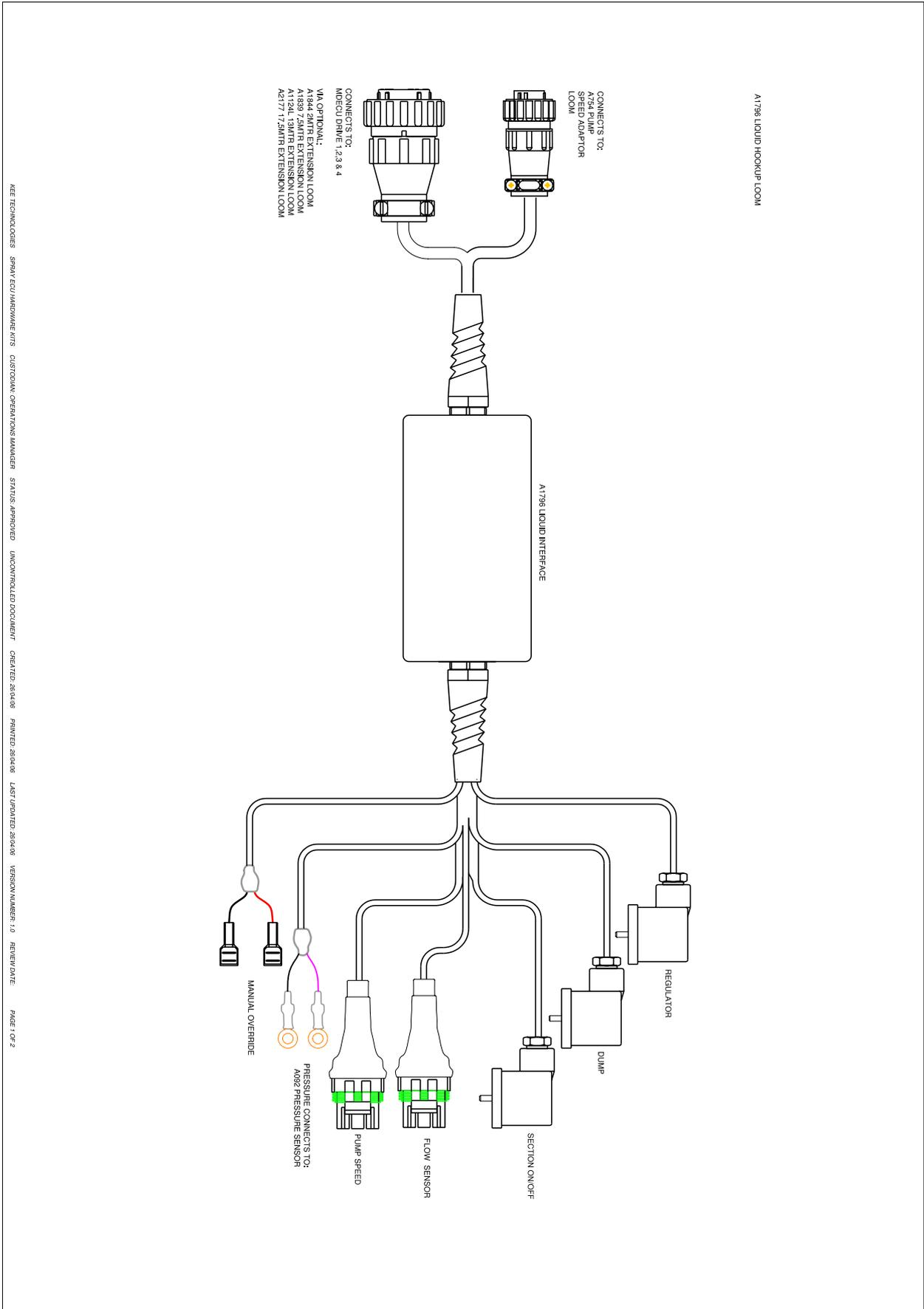

14.8 PUMP SPEED ADAPTOR HARNESS LAYOUT

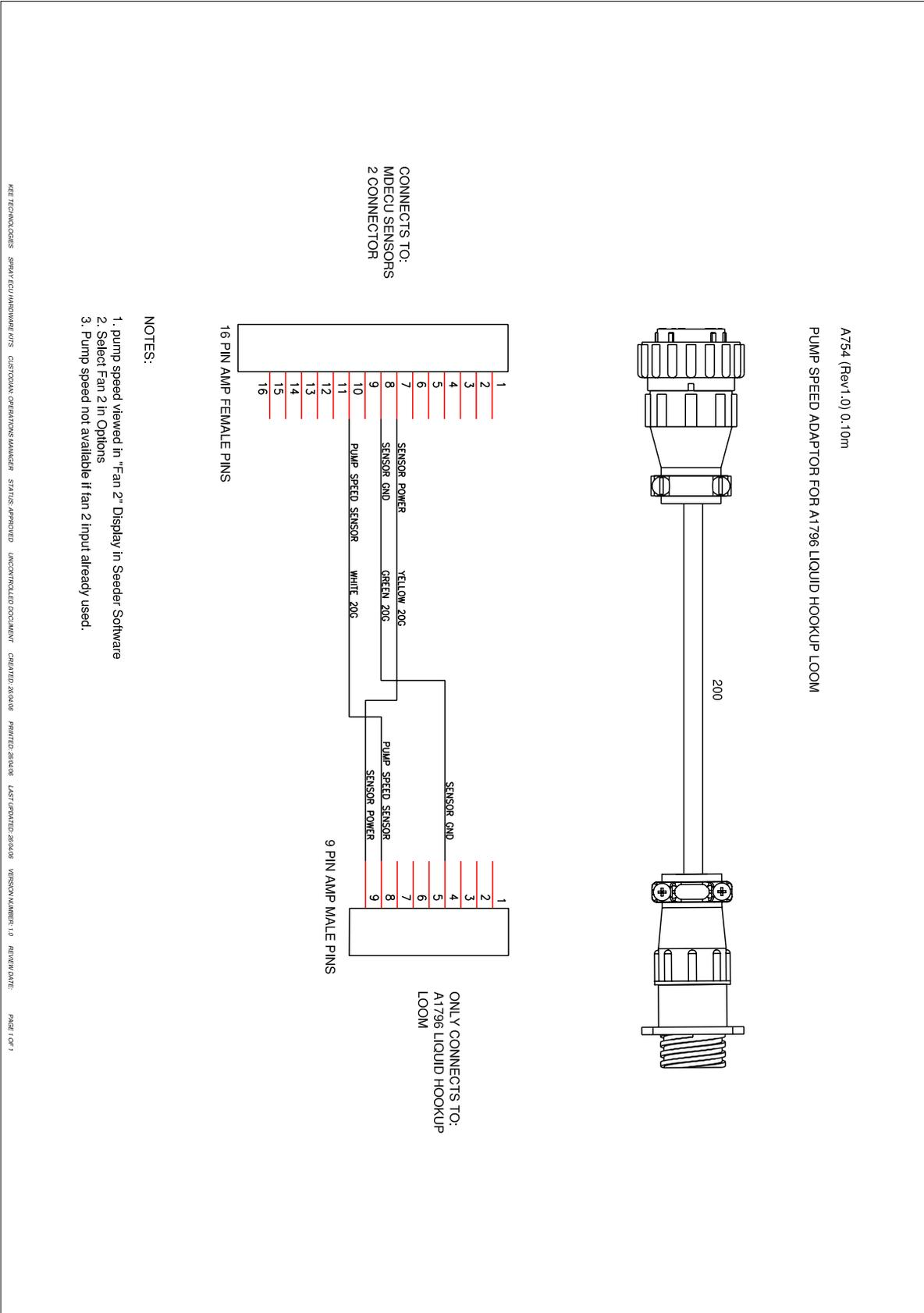



HEAD OFFICE

18 Loudoun Rd
Dalby
Queensland 4405

Office: +61 7 4662 2977
Fax: +61 7 4662 1743

Email: sales@simplicityaus.com.au
website: www.simplicityaus.com.au

The logo for 'Simplicity' is displayed in a stylized, cursive yellow font within a dark green rectangular box. This is a smaller version of the logo seen at the top of the page, positioned in the bottom right corner of the page.